

**DTI**

# **Mobile Radio Networks**

## **Digital Transmission in Interf. Limited Systems**

**Roberto Verdone**  
[www.robertoverdone.org](http://www.robertoverdone.org)

---

# Outline

1. **Fundamentals of Wireless Networking**
2. **Communication Link with Interference: System Model**
3. **Linear and Non Linear Demodulation**
4. **Interference Based Power Control**
5. **Link Performance (BER) of M-QASK with Interference**
6. **Capture Effect**
7. **Direct Sequence Spread Spectrum with Interference**
8. **Link Level Outage Probability with Fading and Interference**
9. **Impact on Interference of Countermeasures to Fading**
10. **Interference Based Power Control Under a Network Level View**
11. **Exercises**

The scope of this lecture block is to introduce the fundamentals of digital transmission techniques for interference limited links. The ultimate goal is the discussion of the concept of *capture effect*.

---

# Capture Effect

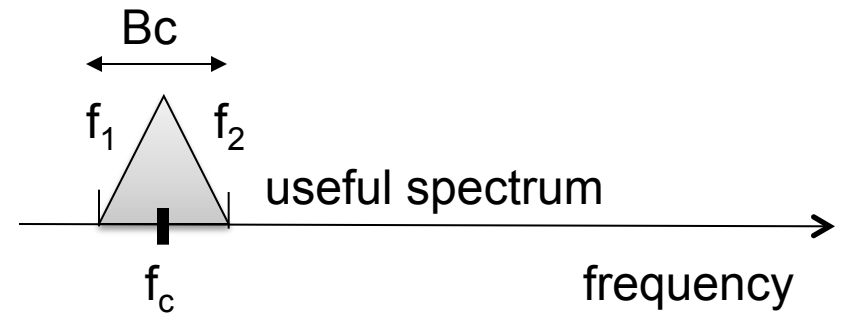
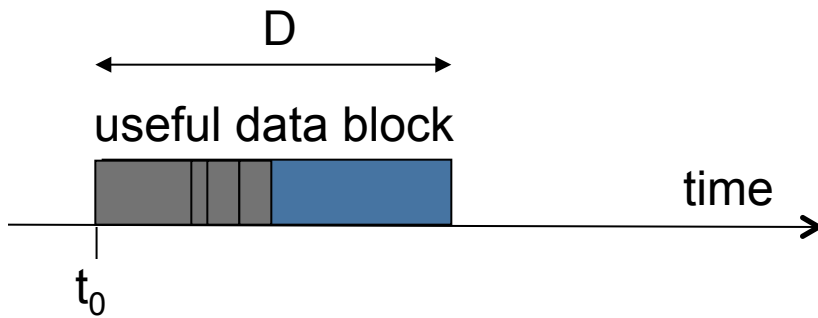
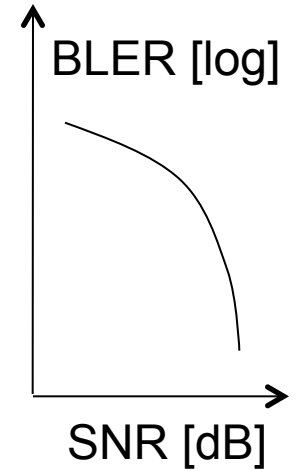
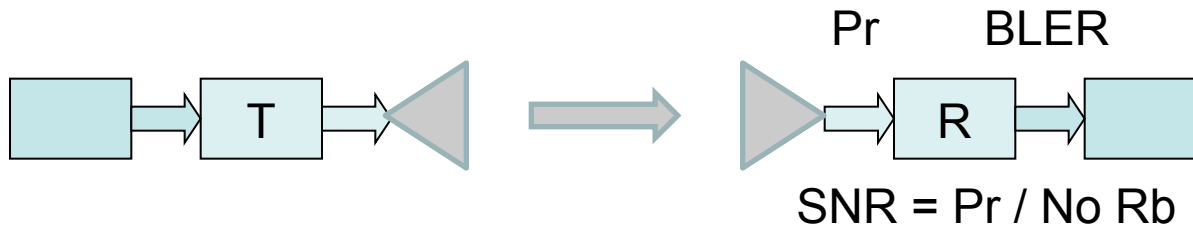

# Capture Effect

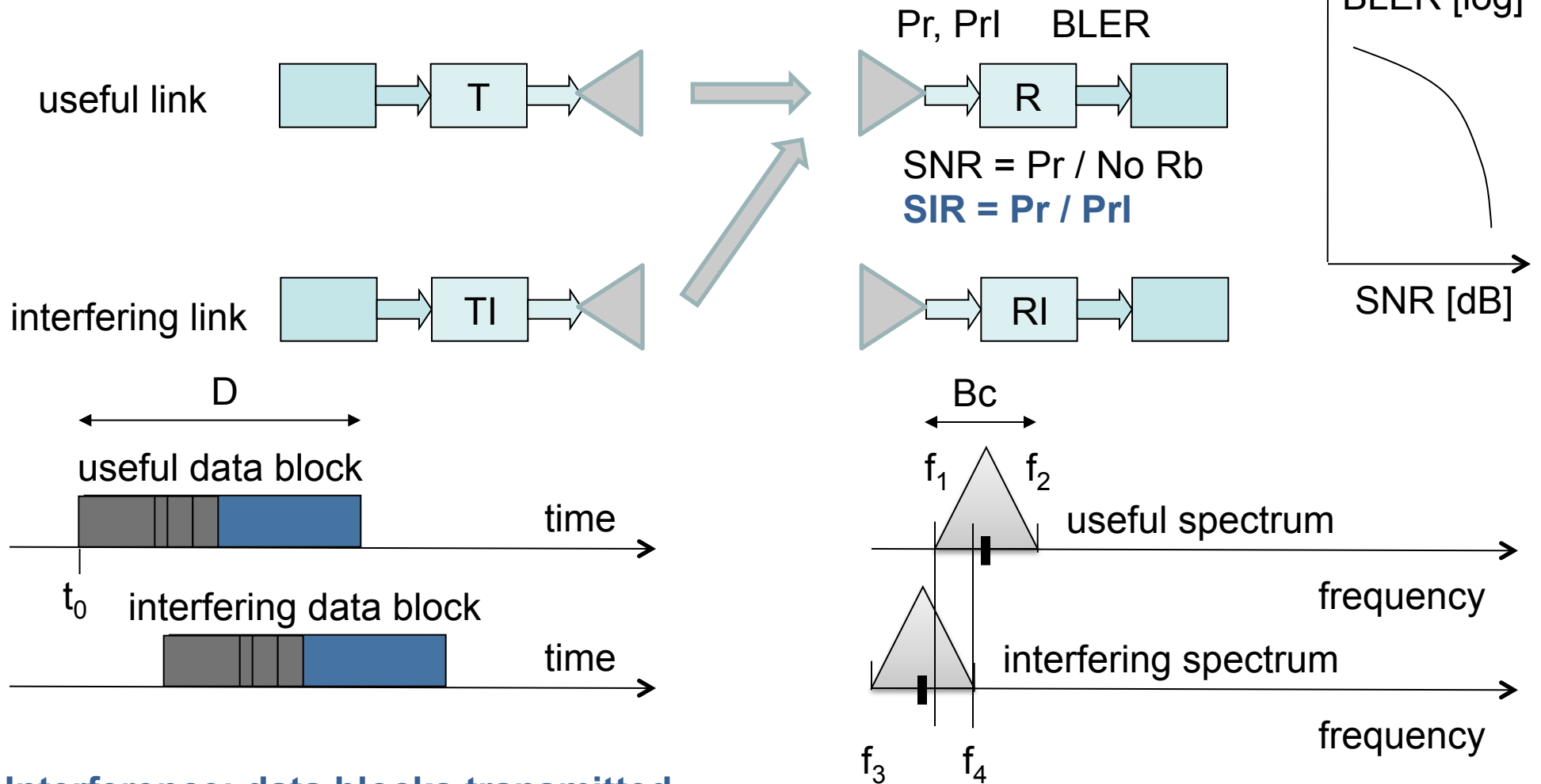

**Interference: data blocks transmitted (at least partially) simultaneously (at least partially) on the same frequencies**

# Capture Effect

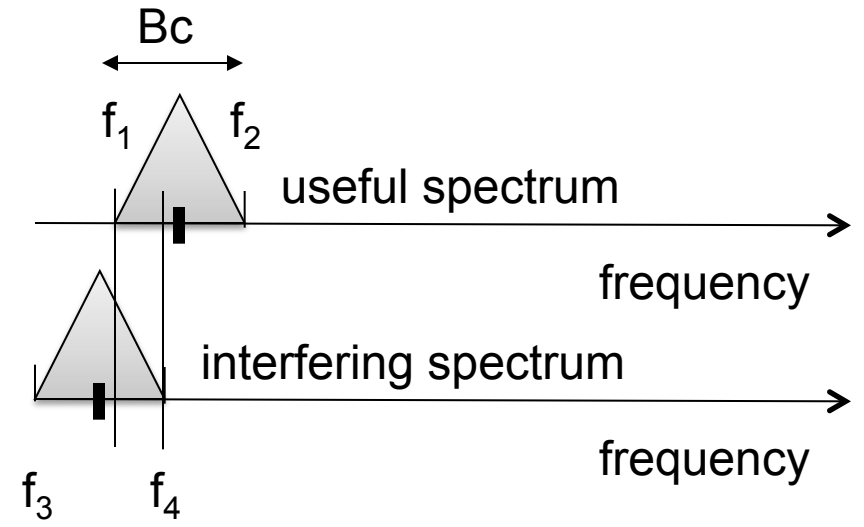
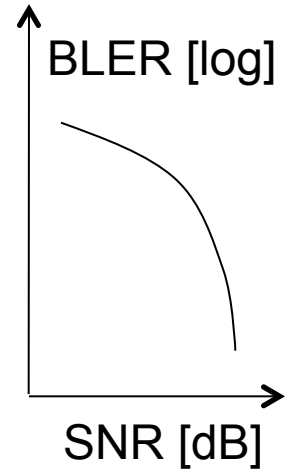
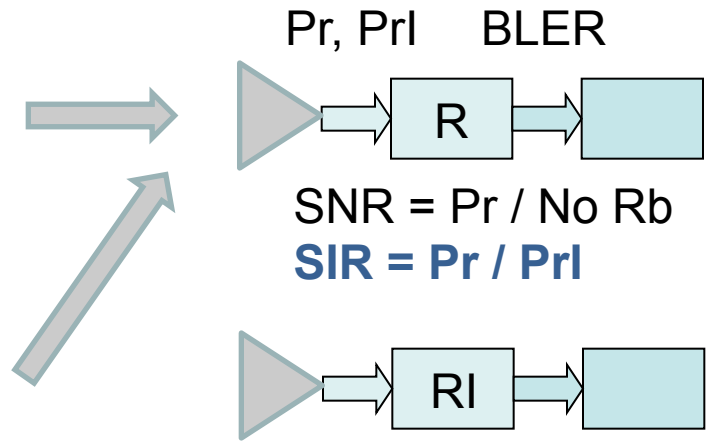
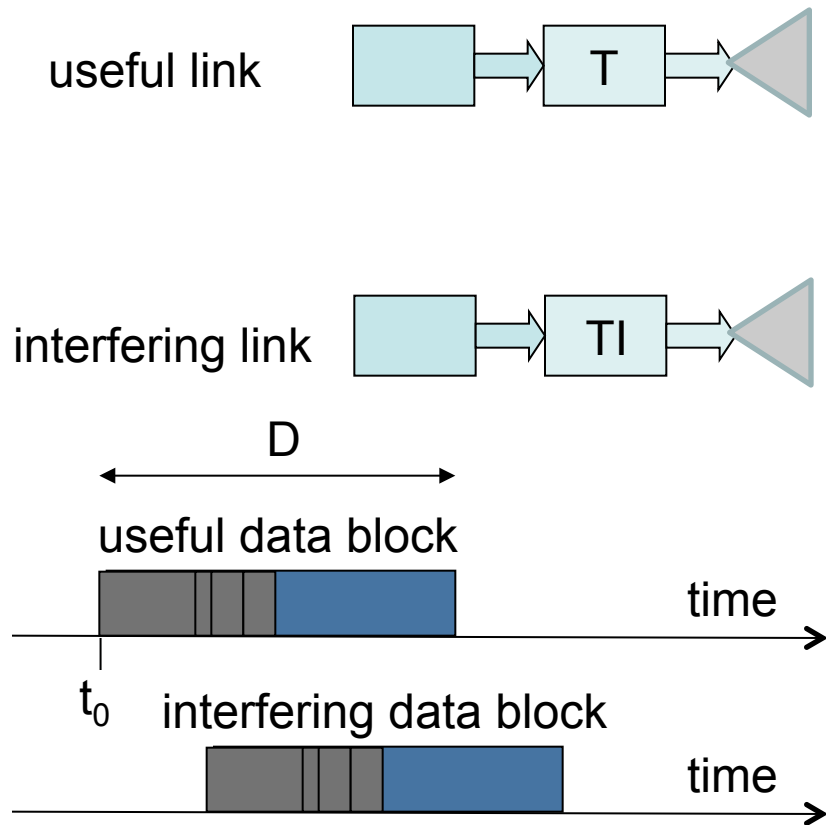

**Collision: data reception is affected by interference**

# Capture Effect

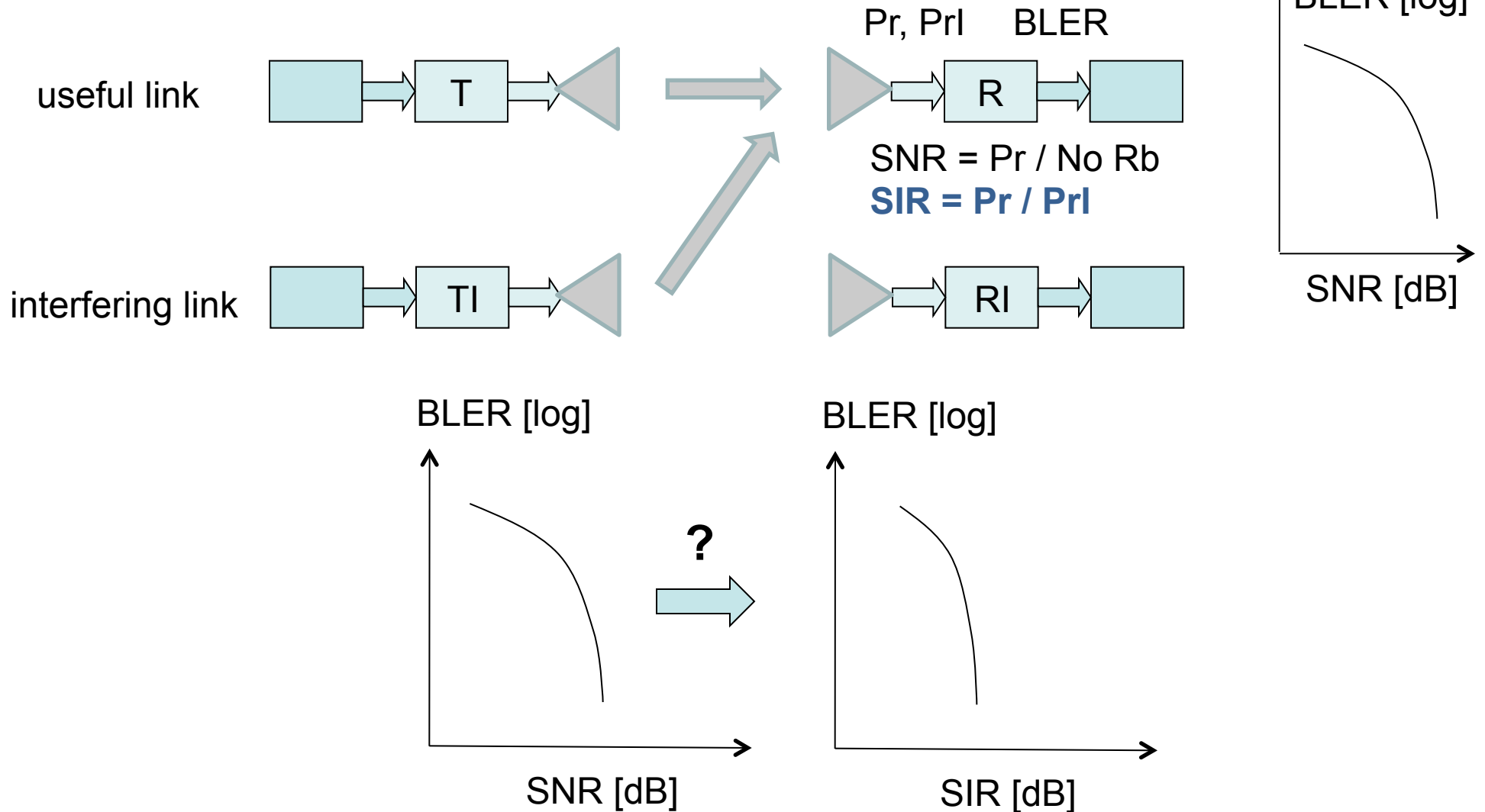

# Capture Effect

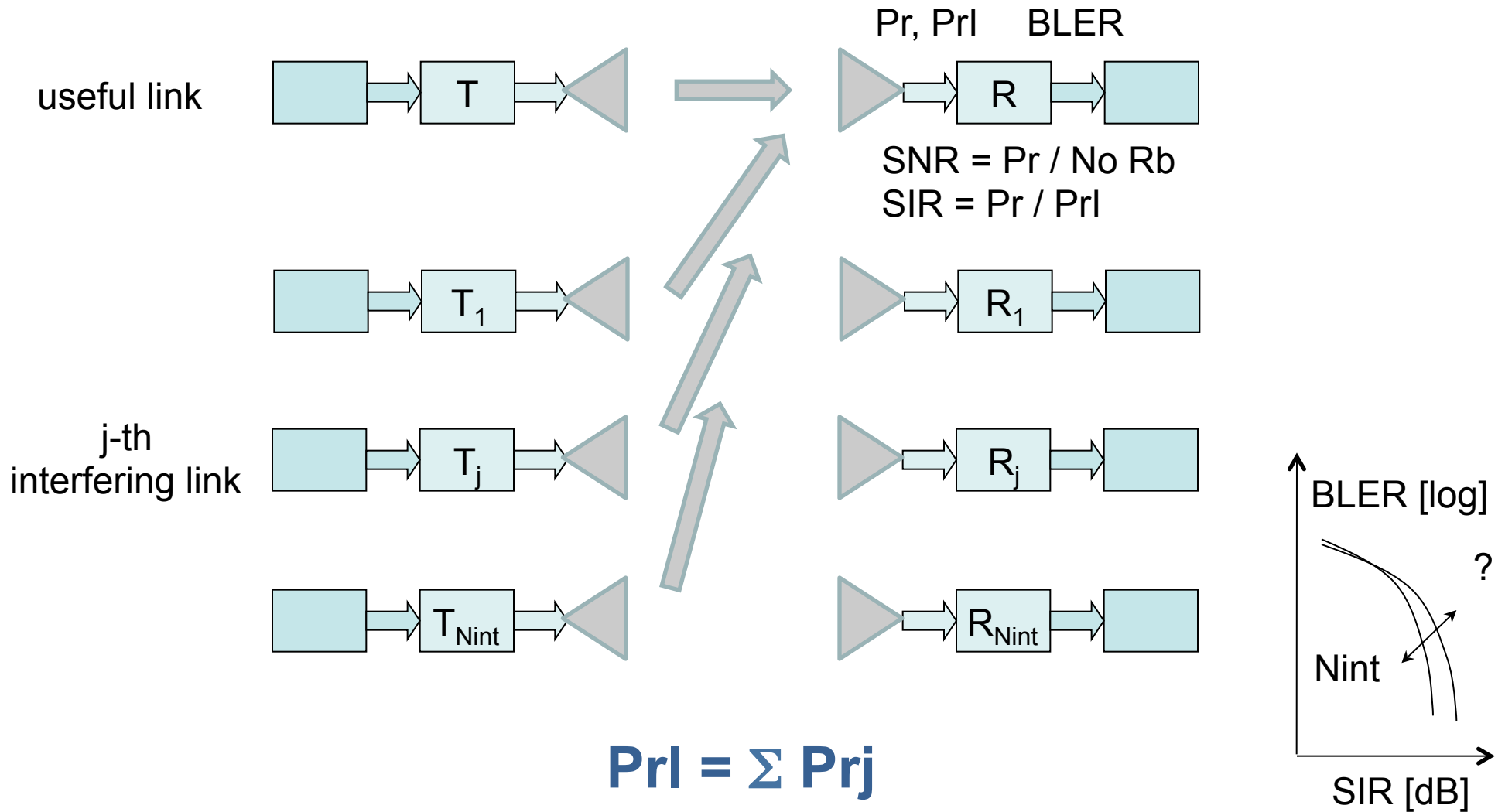

# 1. Fundamentals of Wireless Networking

---



# Fundamentals of Wireless Networking

**Networks**



**Mutual Interactions**

---

# Fundamentals of Wireless Networking

Networks



Mutual Interactions

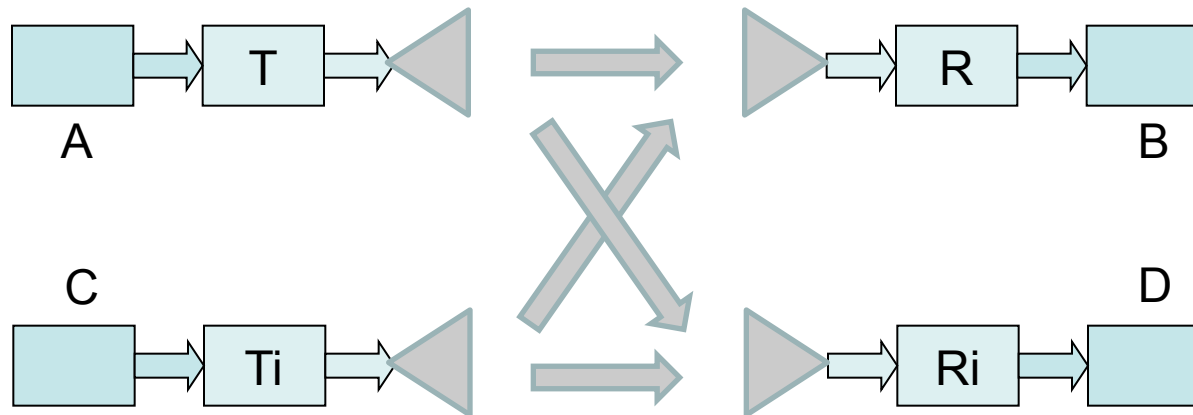

**Interference Management is a key Issue:**

- **Interference Avoidance** → **collision less**
- **Interference Averaging** → **collisions are statistically controlled**
- **Interference Rejection** → **collision less**
- **Collision Resolution** → **collision prone**

# Fundamentals of Wireless Networking

Networks



Mutual Interactions

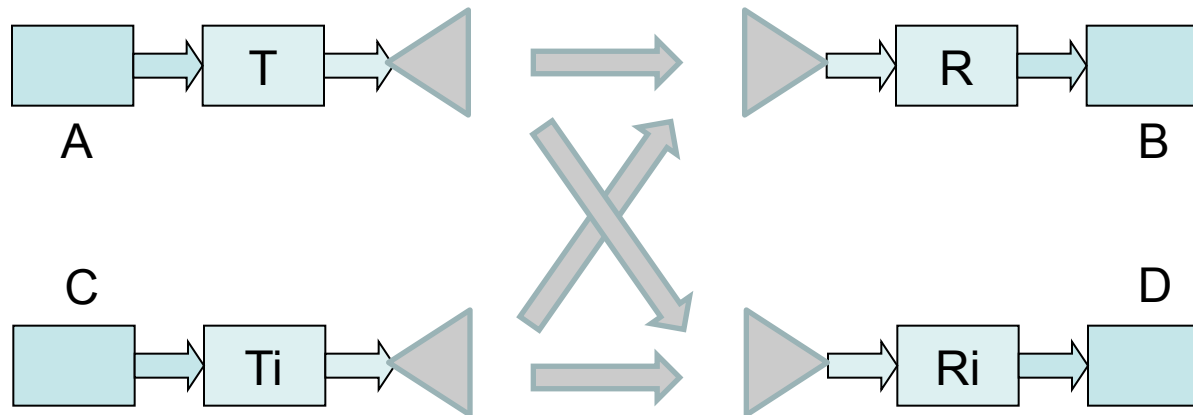

**Interference Management is a key Issue:**

- Interference Avoidance → PHY or DATA LINK or NETWORK Layer
- Interference Averaging → PHY or DATA LINK Layer
- Interference Rejection → PHY Layer
- Collision Resolution → DATA LINK Layer

# Fundamentals of Wireless Networking

Networks



Mutual Interactions

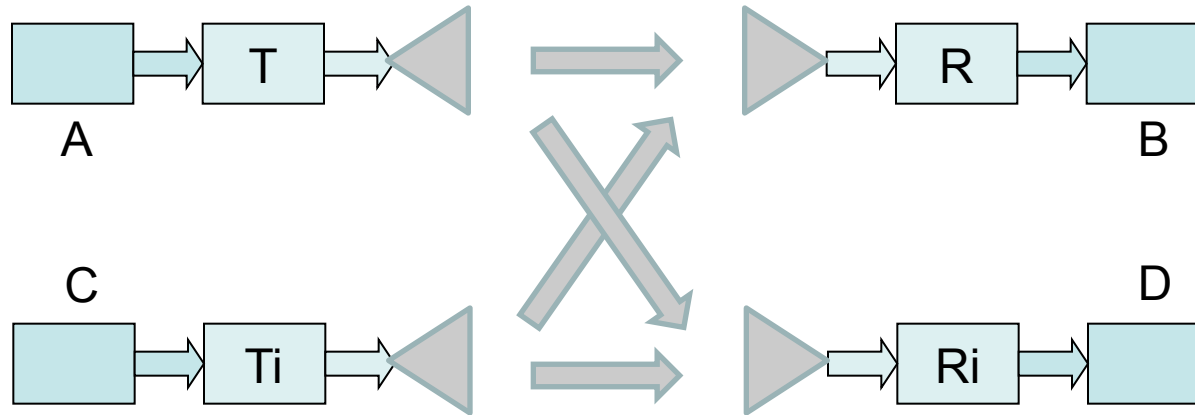

User Plane

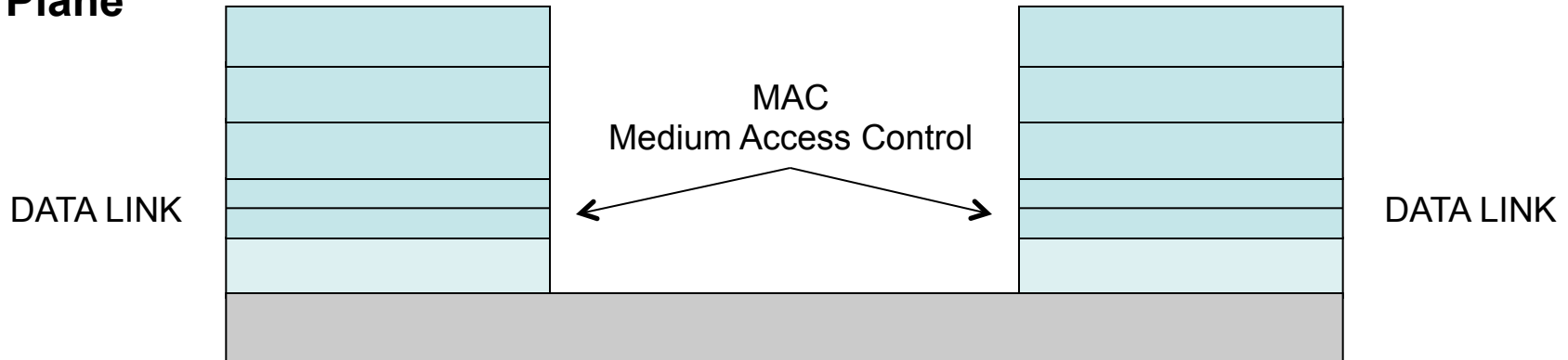

# Fundamentals of Wireless Networking

Networks



Mutual Interactions

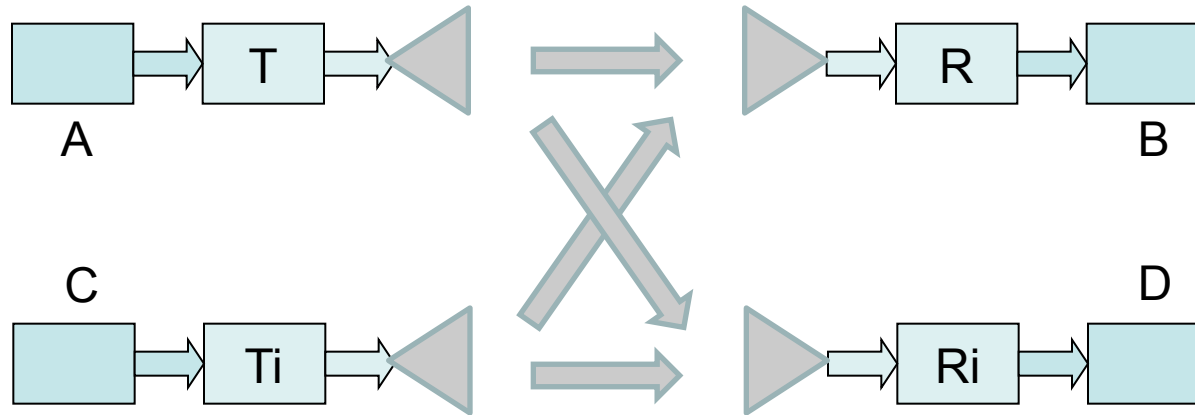

Control Plane

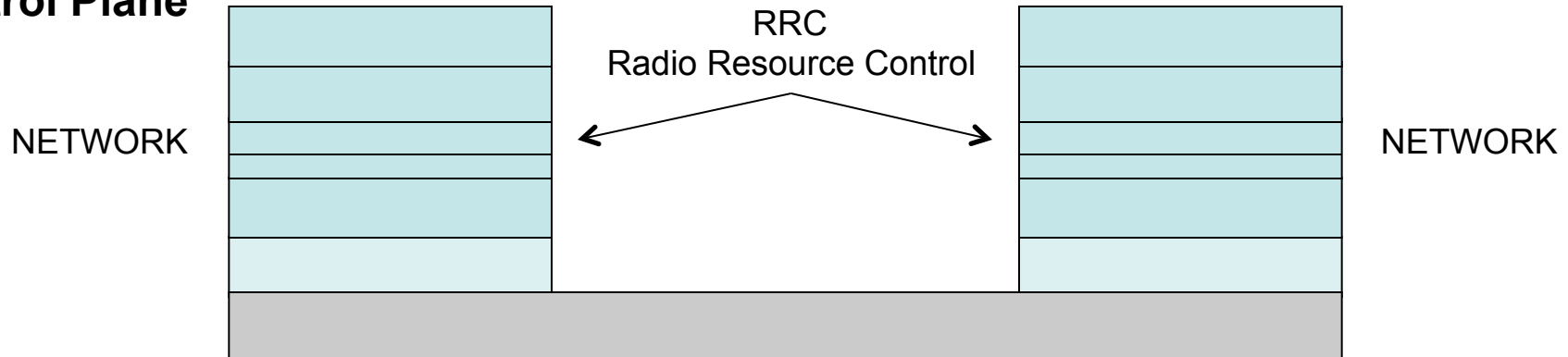

# Fundamentals of Wireless Networking

**Networks**



**Topologies & Architectures**

---

# Fundamentals of Wireless Networking

**Networks**

→ **Topologies & Architectures**

**Mobile Radio Access**

**Broadband Radio Access**

**Local Radio Access**

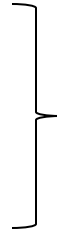

**Area Coverage → Cellular Networks**

**Mobile Ad Hoc**

**Device Centric → Peer-to-Peer Networks**

**Personal**

**Sensor**

**Body**

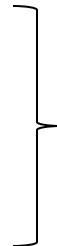

**Data Centric → Coordinator Based Networks**

# Fundamentals of Wireless Networking

## Networks

Mobile Radio Access

Broadband Radio Access

Local Radio Access

Mobile Ad Hoc

Personal

Sensor

Body



## Topologies & Architectures

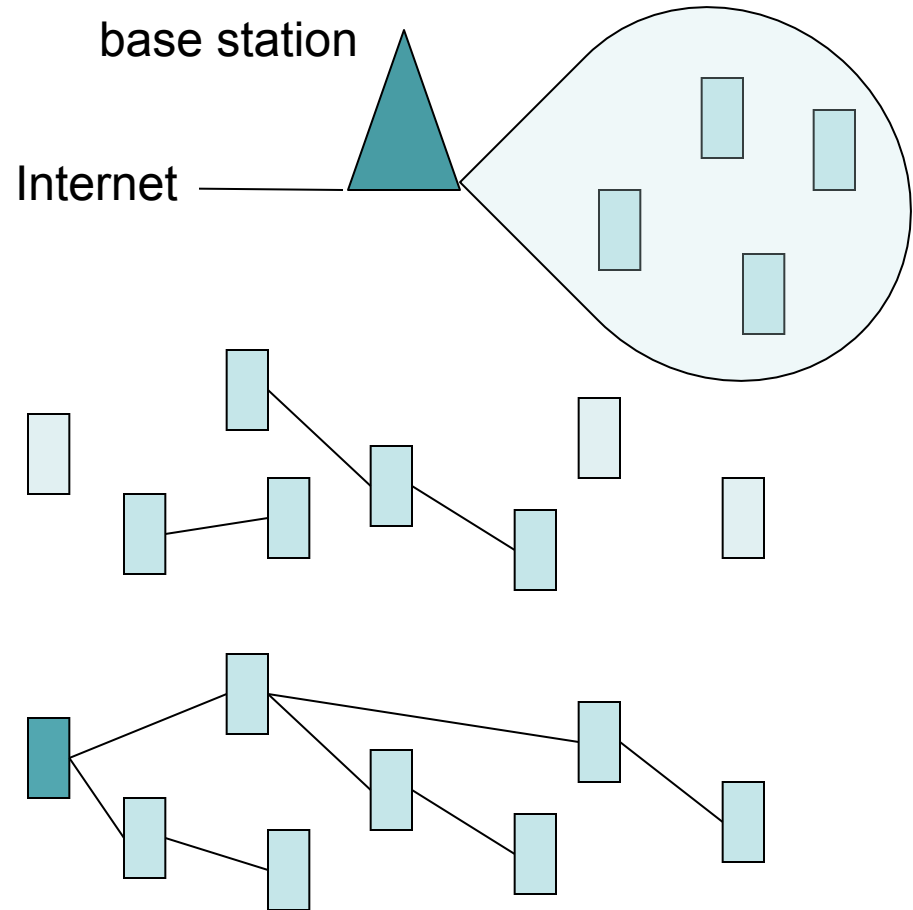



# Fundamentals of Wireless Networking

**Networks**



**Network Performance**

---

# Fundamentals of Wireless Networking

Networks



Network Performance

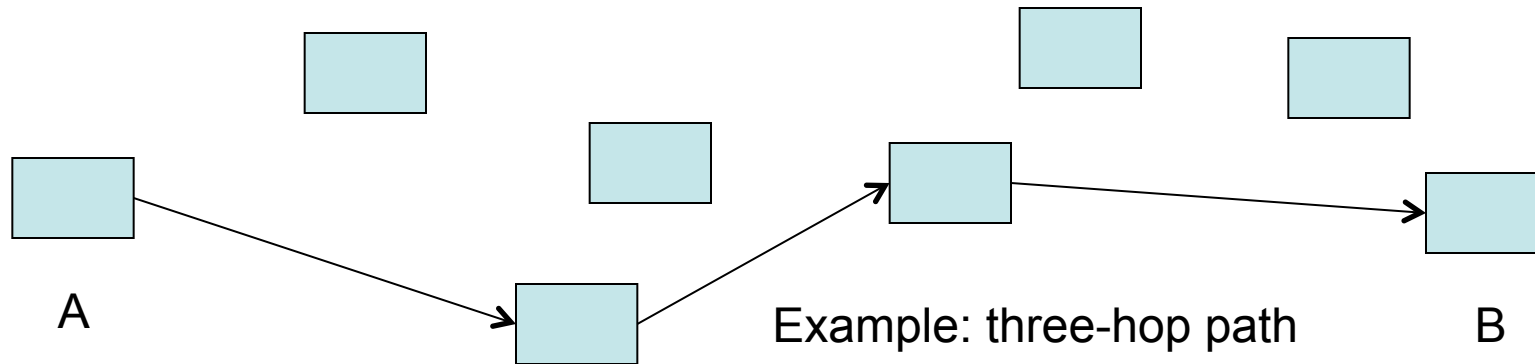

## Path Capacity:

maximum amount of bit rate that can be transmitted over the path with Bit Error Rate zero.

$$C_p = \min [ C_i ]$$

$C_i$  = capacity of the  $i$ -th hop of the path

# Fundamentals of Wireless Networking

Networks



Network Performance

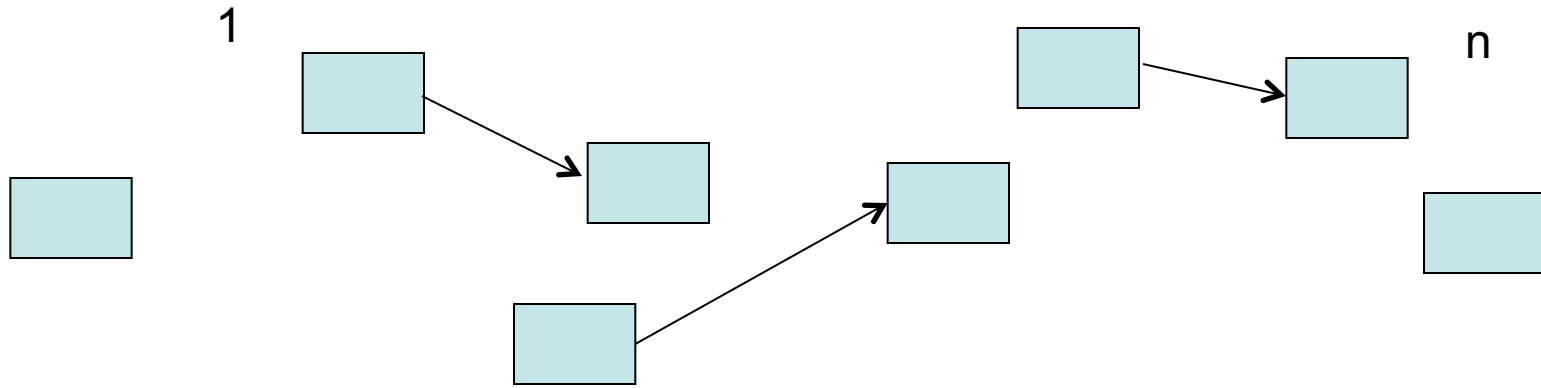

## Network Capacity:

maximum amount of *bit-meters per second* [bm/s] that can be transmitted in a random network (square with  $n$  randomly uniformly distributed nodes).

$C_n$  is prop to  $B_c * \sqrt{n}$

[Gupta, Kumar, 2000]

# Fundamentals of Wireless Networking

Networks



Network Performance

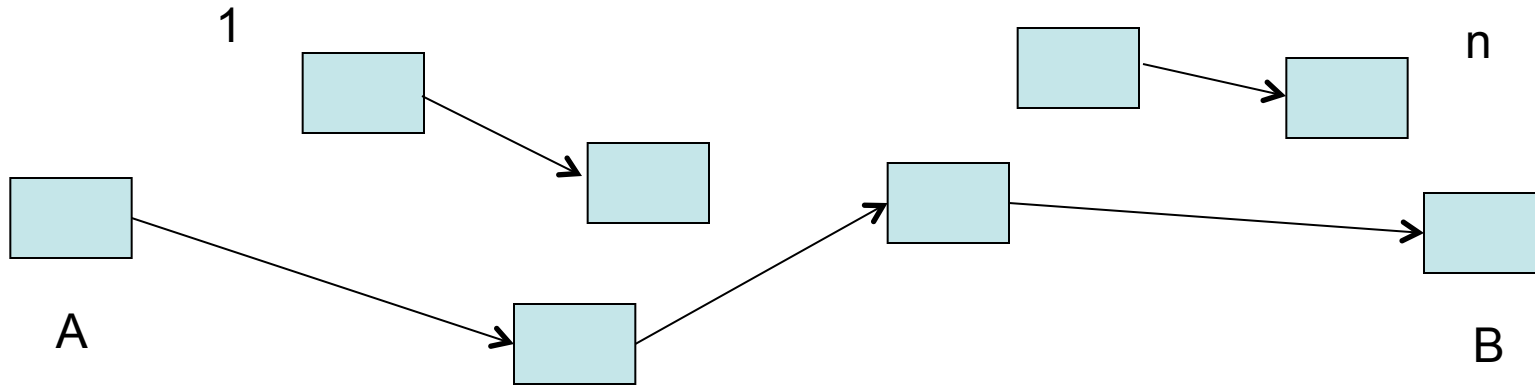

$$C_n \text{ is prop to } B_c * \text{sqrt}(n)$$

$$C_p = \min [ C_i ]$$

More Connected Devices →  
Higher Overall Throughput  
Lower User Throughputs

Shorter Links →  
Higher Overall Throughput

## 2. Communication Link with Interference: System Model

# Communication Link with Interference: System Model

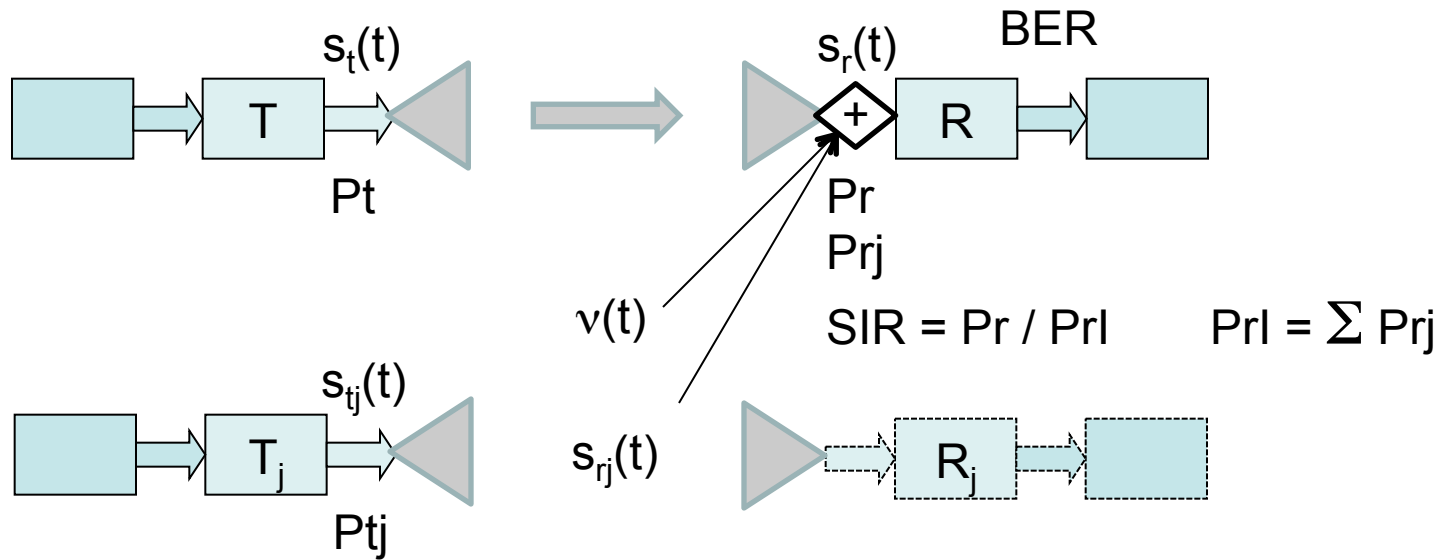

# Communication Link with Interference: System Model

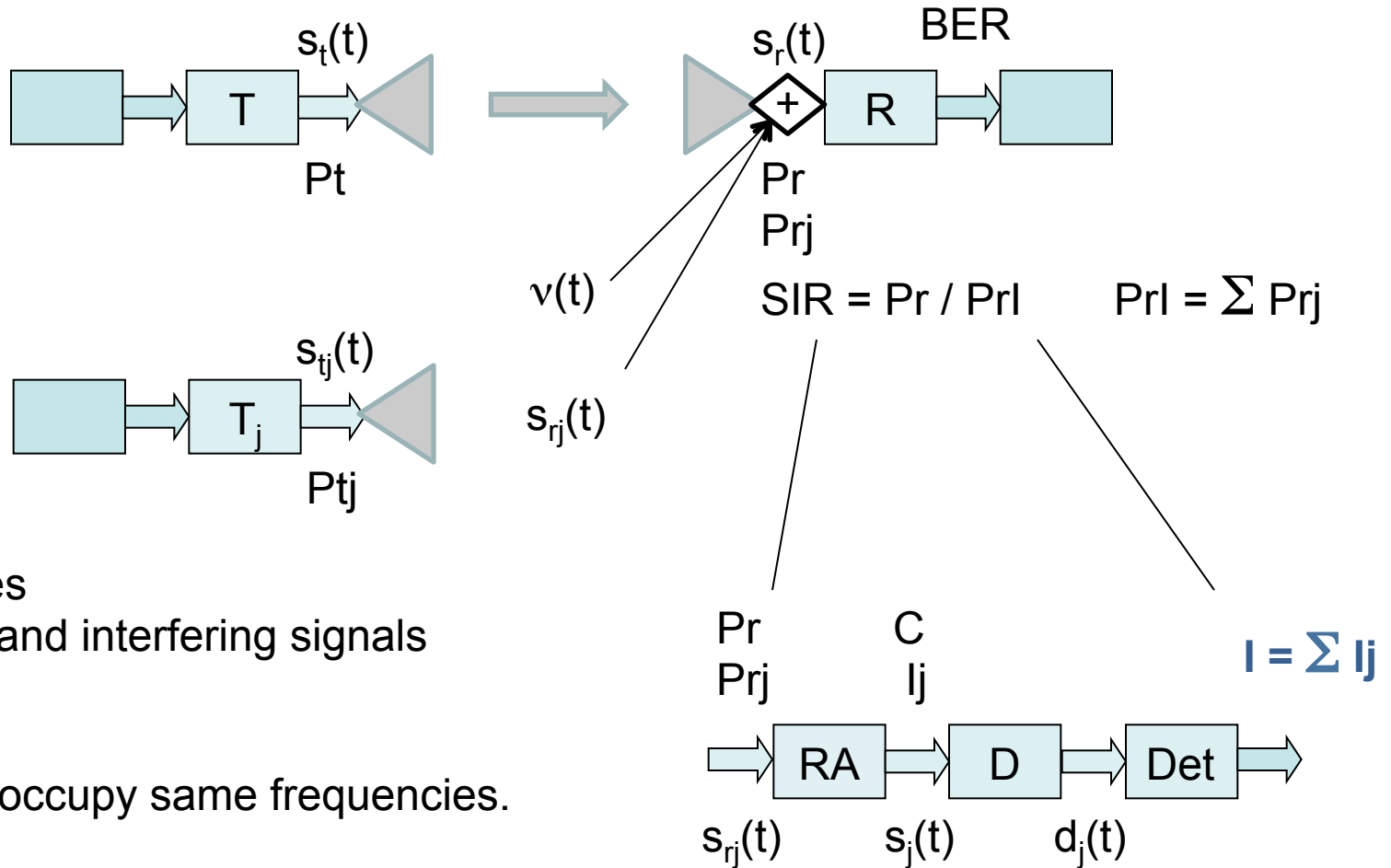

The RA amplifies both the useful and interfering signals with same gain if the two signals occupy same frequencies. Then:

$$C/I = SIR$$

# Communication Link with Interference: System Model

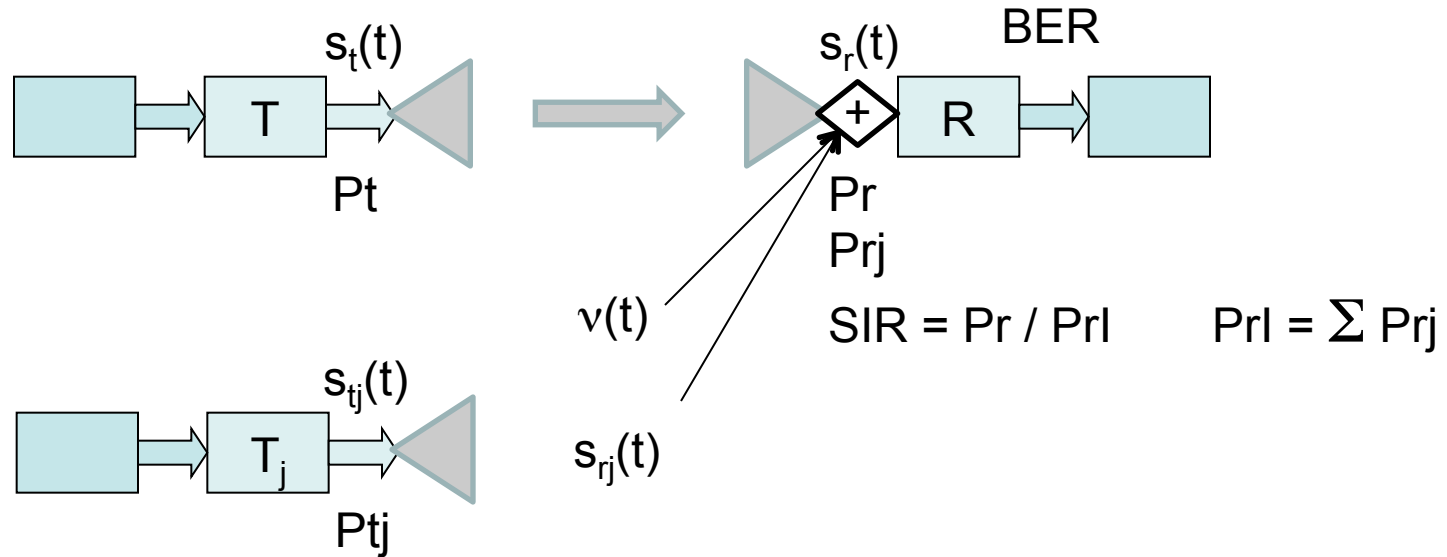

$s_{tj}(t)$  with respect to  $s_t(t)$

has different

and possibly

symbols

carrier phase

symbol synchronisation

transmit power

MCS

carrier frequency

bandwidth

$s_{rj}(t)$  is a random process from the pov of R



# Communication Link with Interference: System Model

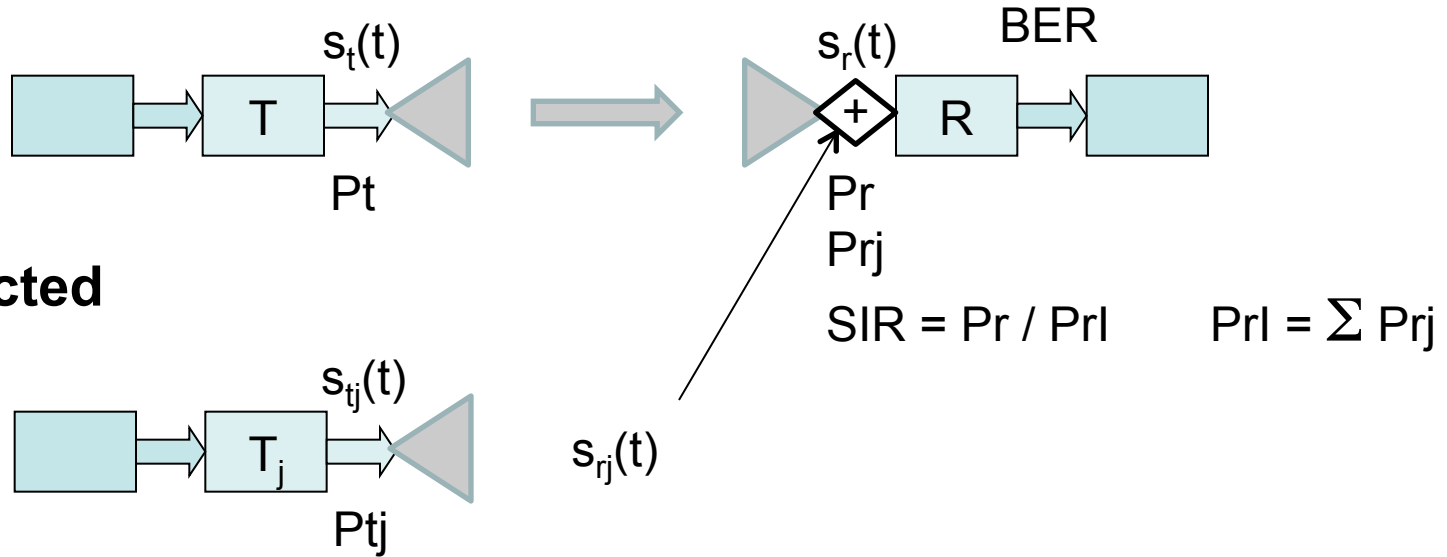

**Noise neglected**

# Communication Link with Interference: System Model

**Interference limited system**

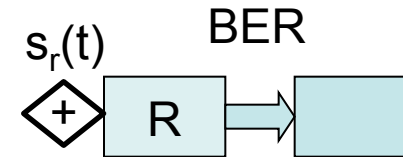
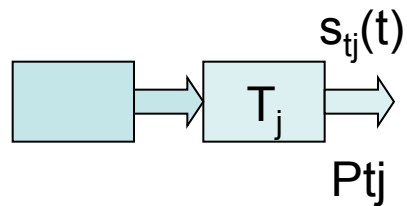
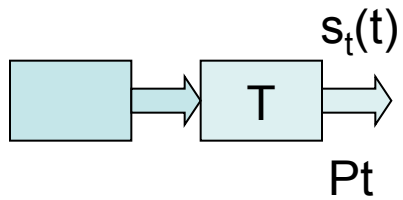

$P_r$

$P_{rj}$

$$SIR = P_r / P_{rI}$$

$$P_{rI} = \sum P_{rj}$$

$$A = P_t / P_r$$

$$A_{ij} = P_{tj} / P_{rj}$$

$$A_j = \dots$$

# Communication Link with Interference: System Model

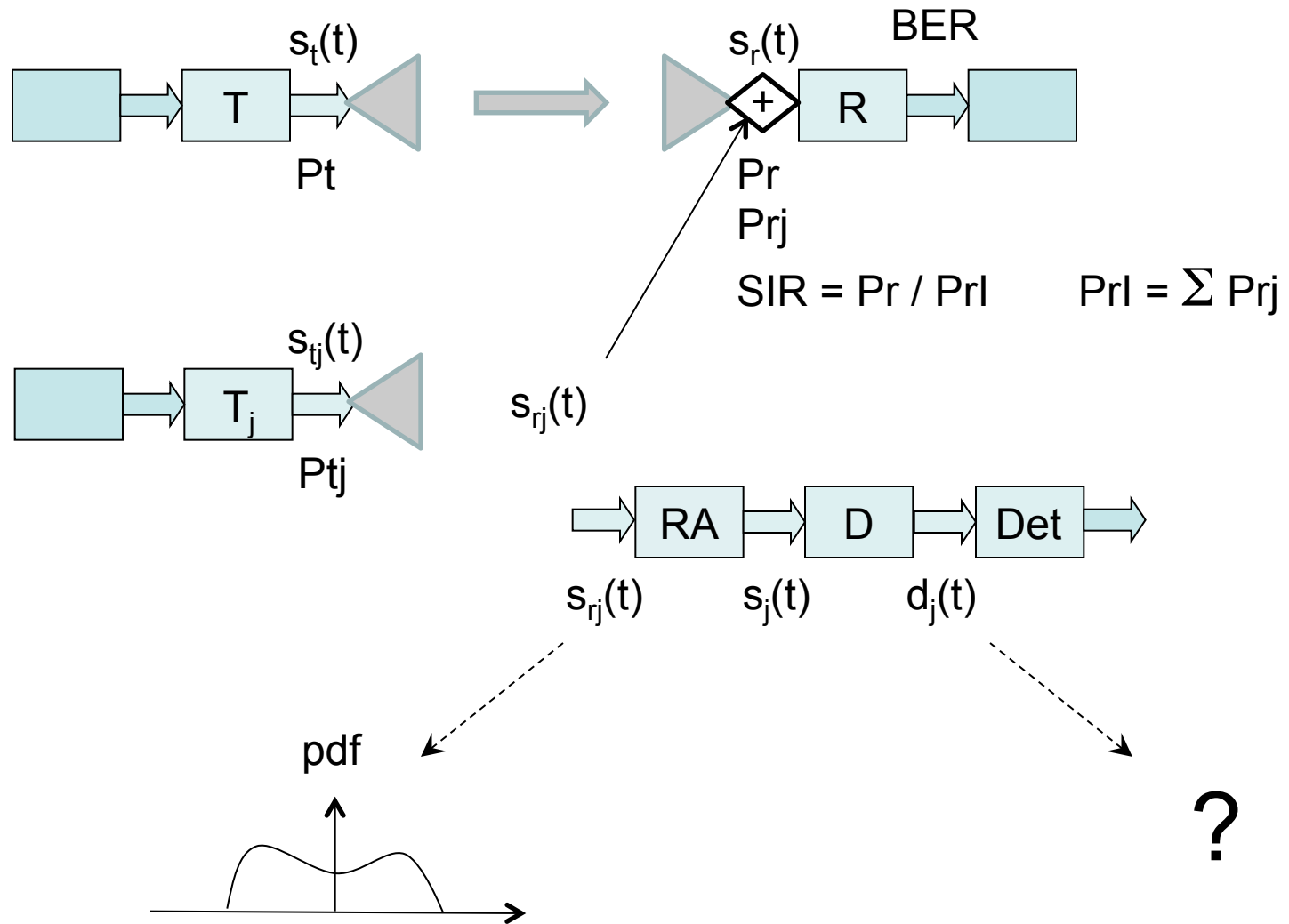

# 3. Linear and Non Linear Demodulation

---

# Communication Link with Interference: System Model

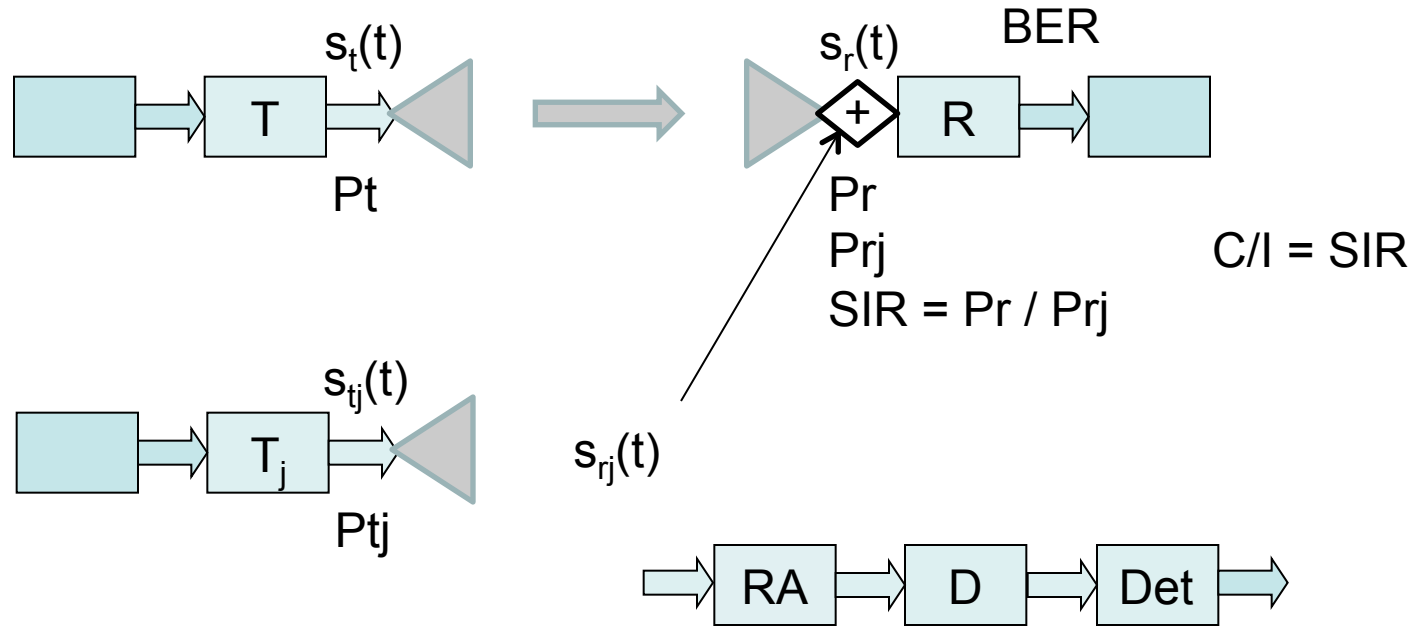

## Linear Demodulation



# Communication Link with Interference: System Model

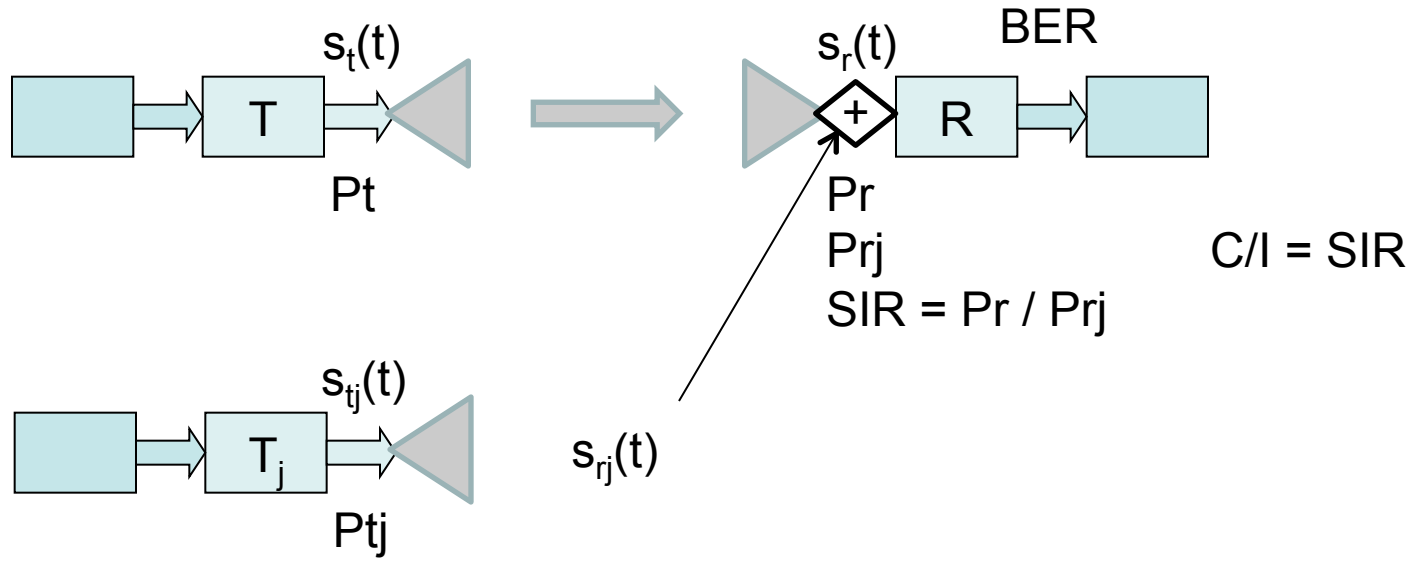

## Linear Demodulation

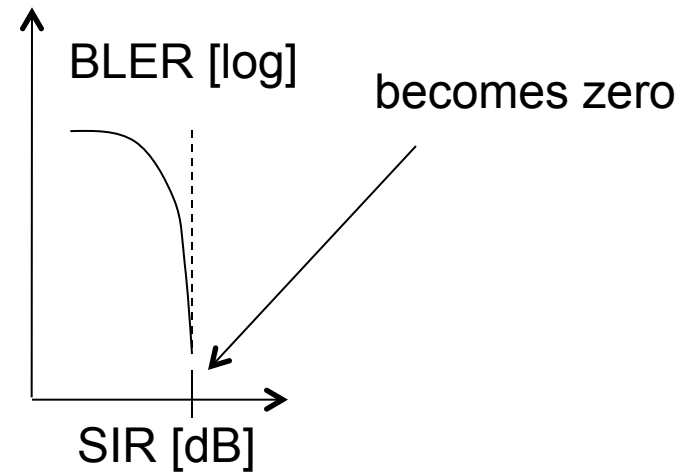

# Communication Link with Interference: System Model

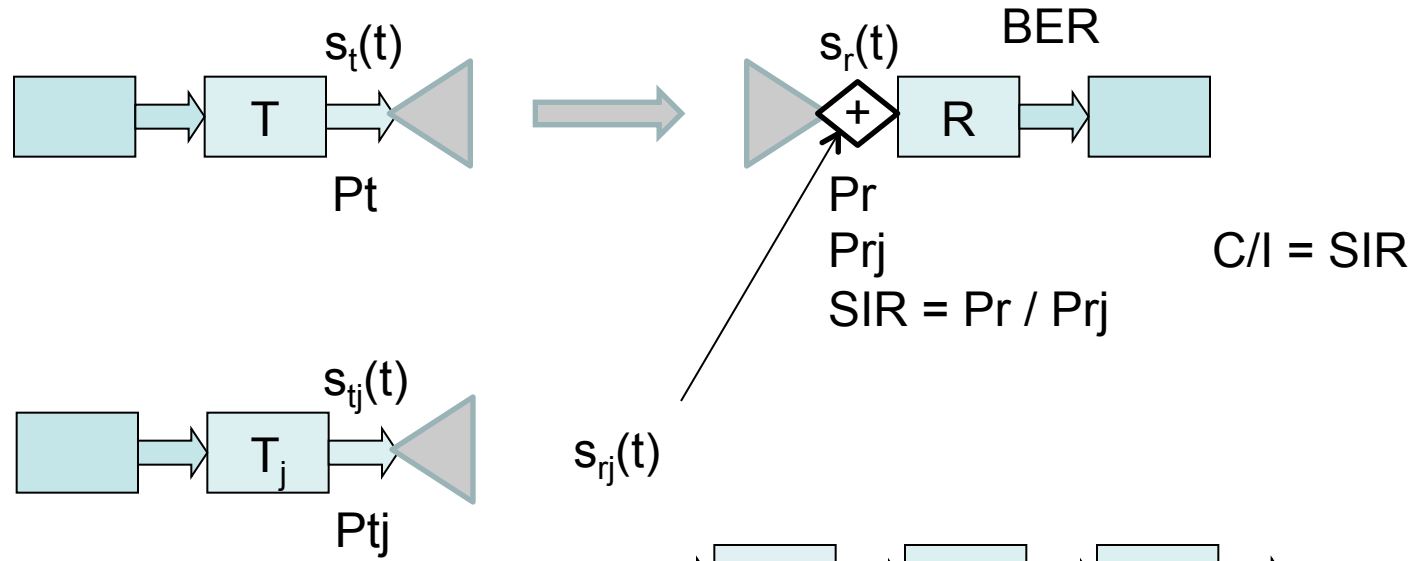

## Non Linear Demodulation

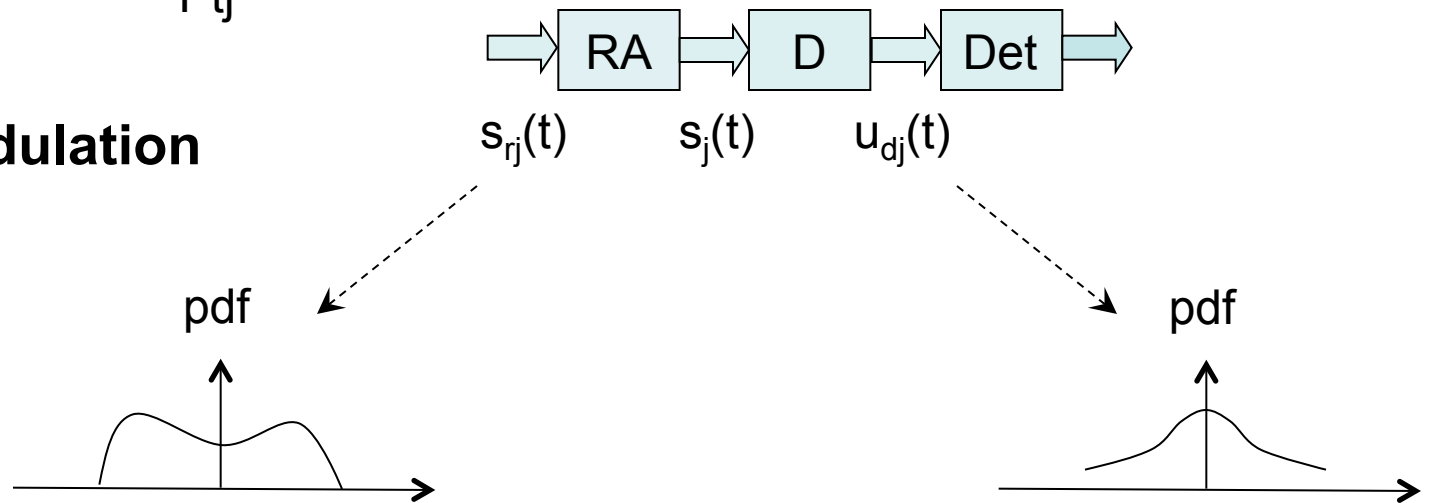

# Communication Link with Interference: System Model

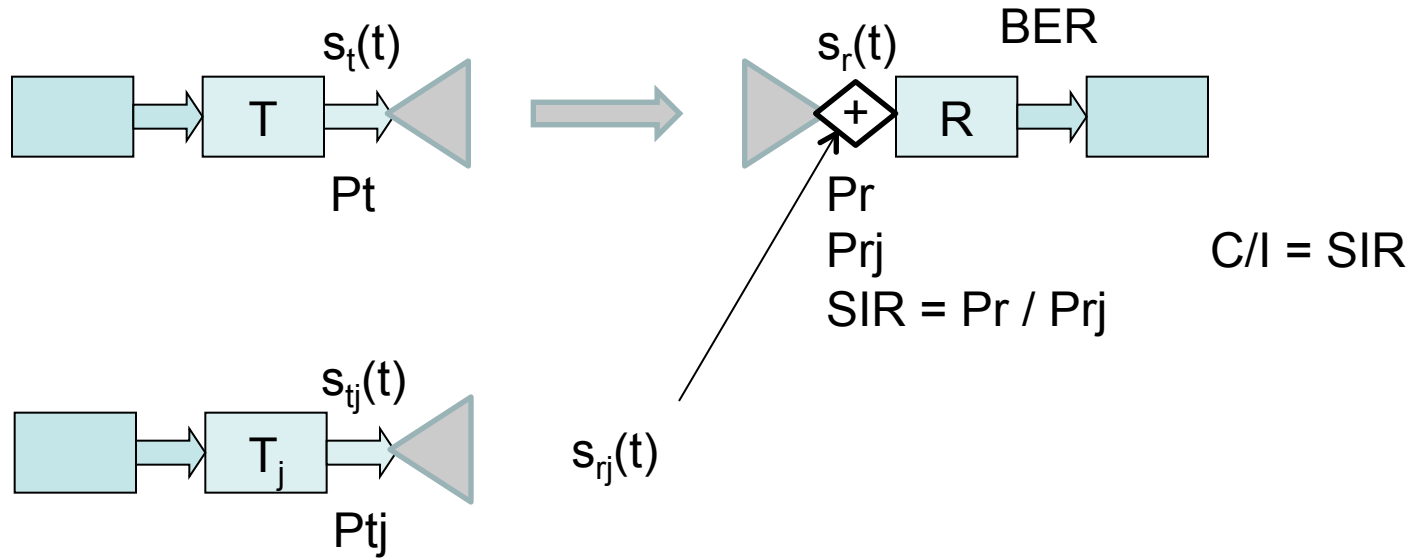

**Non Linear Demodulation**

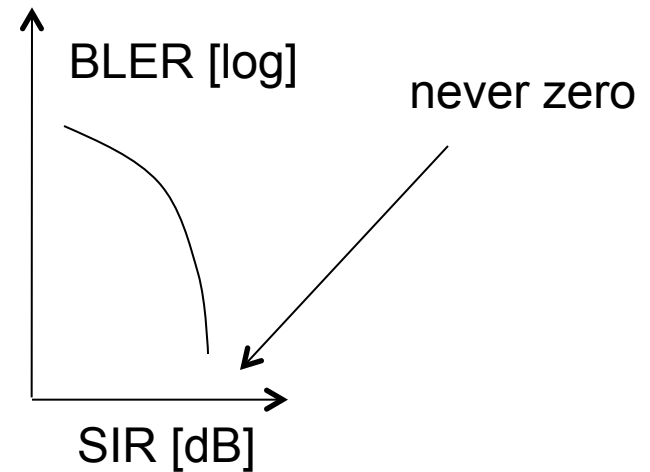



# Communication Link with Interference: System Model

## Noise limited system

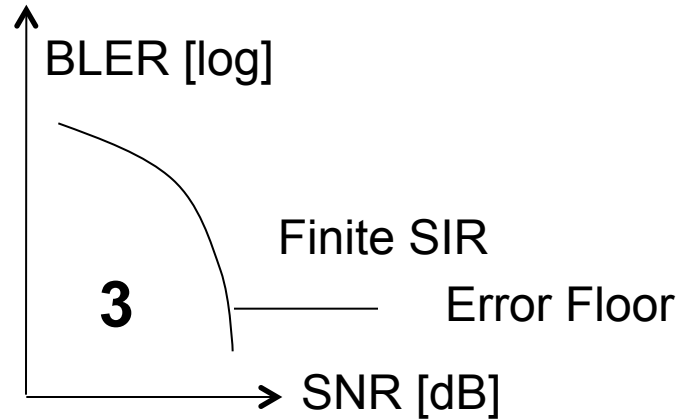
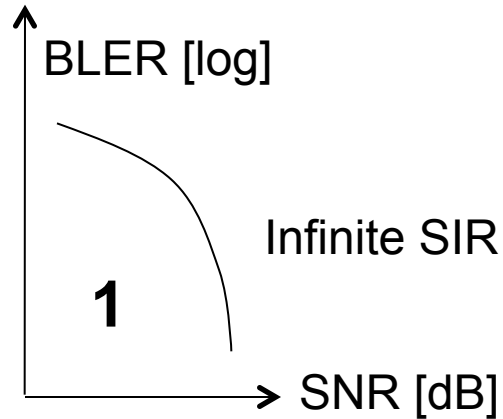

$$C = Bc \log_2 [ 1 + \text{SNR} ]$$

## Interference limited system

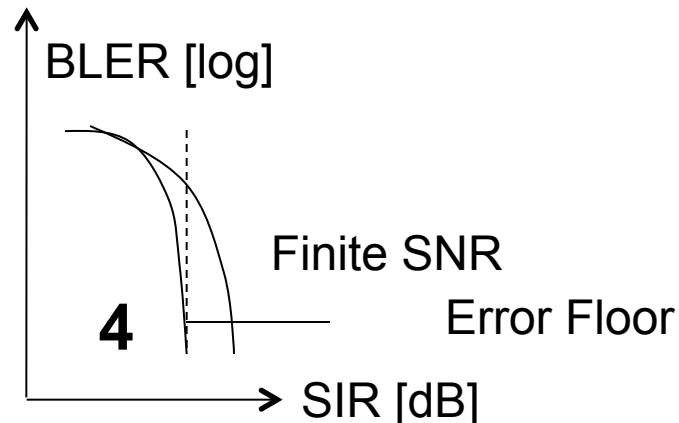
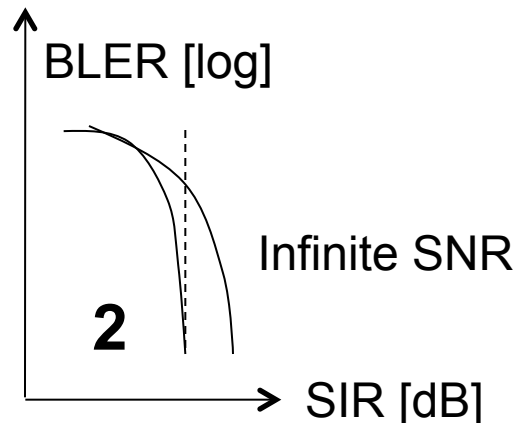

$$C \approx Bc \log_2 [ 1 + \text{SIR} ]$$

# Communication Link with Interference: System Model

## Noise limited system

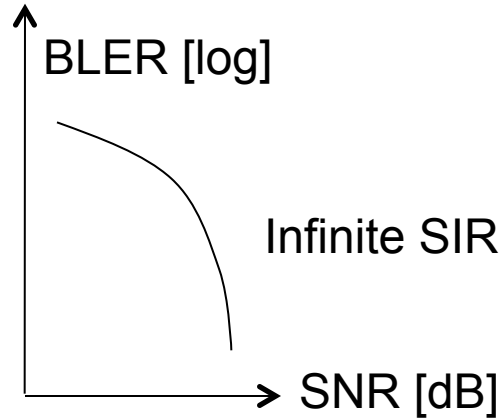

$$\dots \text{SINR} = P_r / (P_n + P_{rI})$$

???

## Interference limited system

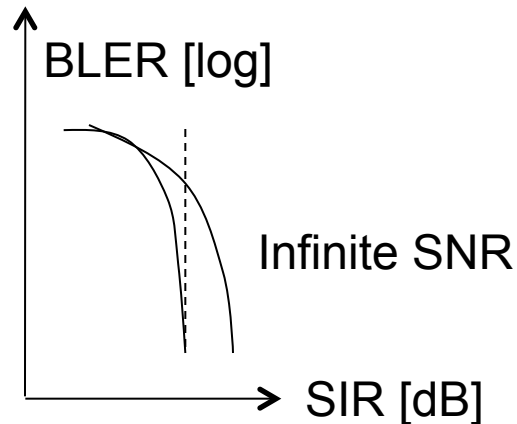

**Interference is not Gaussian!**

$$C \approx B_c \log_2 [ 1 + \text{SINR} ]$$

# Communication Link with Interference: System Model

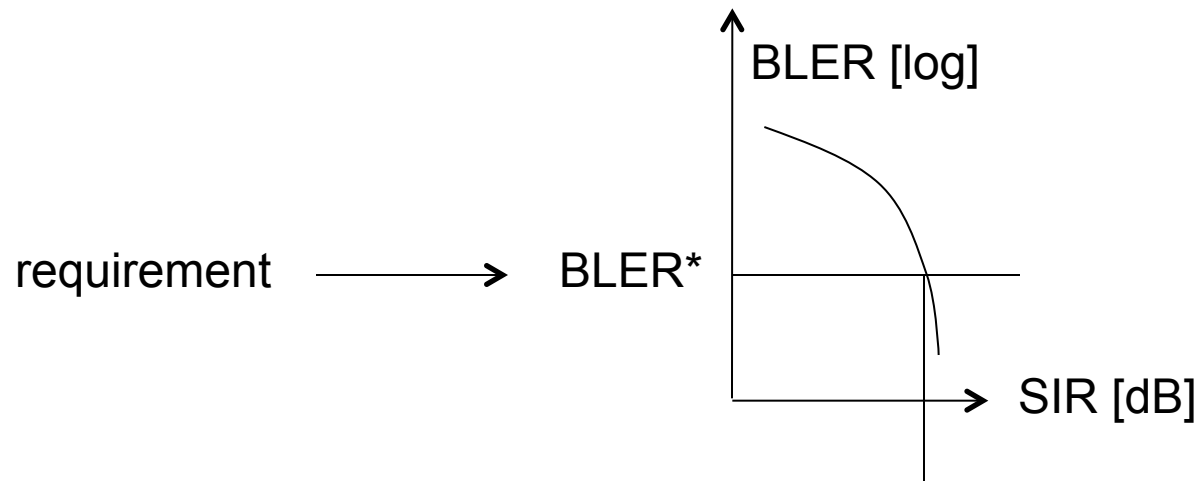
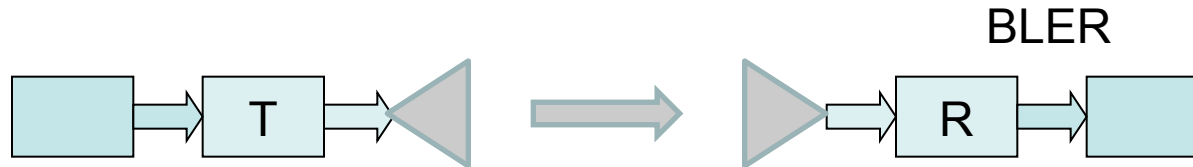

$$Pr / Prl_{min}$$

denoted as **protection ratio**  $\alpha$

# 4. Interference Based Power Control

---

# Interference Based Power Control

The transmit power  $P_t$  is set by the transmitter to a value in the range  $[P_{tmin}, P_{tmax}]$  adapted to the level of SIR. The larger is SIR, the lower is the next value of transmitted power  $P_t$ . PC is effective for flat interference channels, provided the SIR can be measured/estimated.

Scope of PC (same as for Signal Based PC):

- reduction of energy consumed at transmitter
- reduction of e.m. radiation and impact on environment / humans
- reduction of interference towards other systems

The control loop of PC includes:

- 1) measurement or estimation of SIR**
- 2) decision on the next value of  $P_t$
- 3) setting of the level of  $P_t$

# Interference Based Power Control

Open loop PC: impossible.

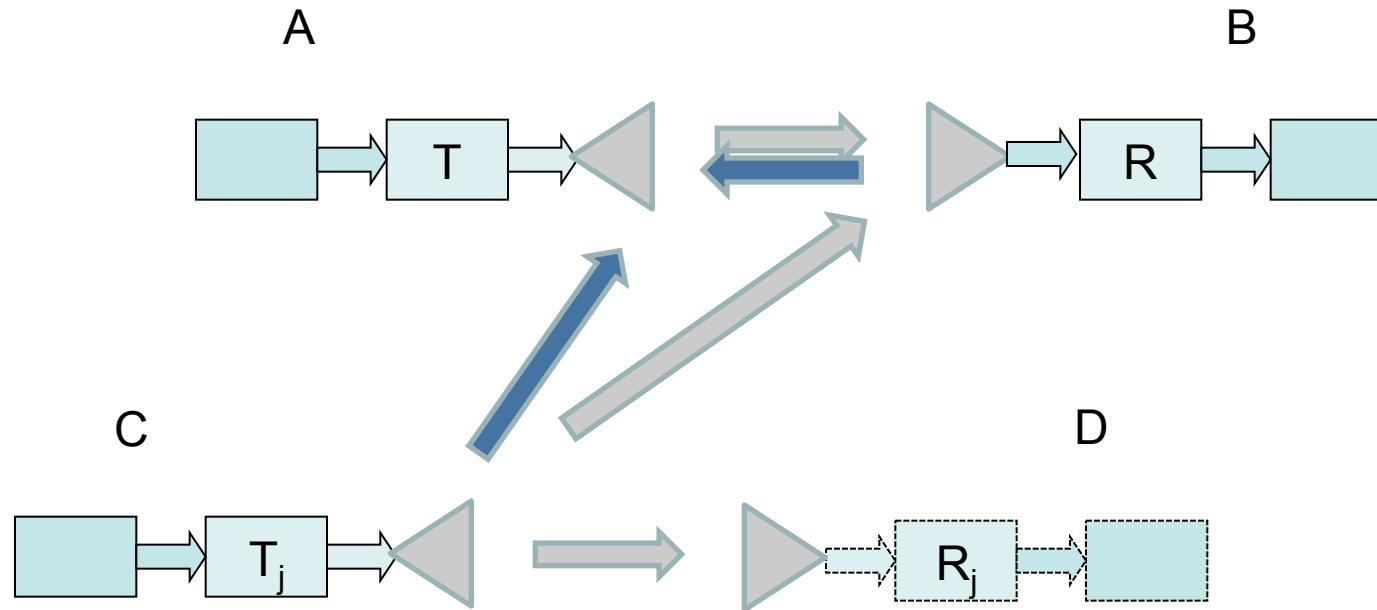

# Interference Based Power Control

**Open loop PC: impossible.**

**Closed loop PC: estimation of SIR happens on the receiver side, through measurements, and PC commands are sent to the transmitter. Loop delay depends on the transmission rate of PC commands.**

**Fast PC: changes in the level of  $P_t$  are made at a rate in the order of 10-1000 Hz.**

**Slow PC: changes in the level of  $P_t$  are made at a rate in the order of 0.1-1 Hz.**

---

# Interference Based Power Control

## How to measure/estimate SIR?

The SIR can not be measured directly, as the received useful signal is summed to the interference. What can be measured at RF is  $RSSI = P_r + P_{rI}$  (**Radio Signal Strength Indicator**).

If the receiver chain includes some technique to cancel interference, after its cancelation  $P_r$  can be assessed.

Through subtraction,  $P_{rI}$  and therefore SIR can be deduced.

Systems using DSSS modulation can use Interference Based Power Control.

Alternatively, the SIR is estimated after detection.

---



# 5. Link Performance: M-QASK with Interf.

# Link Performance of M-QASK with Interference

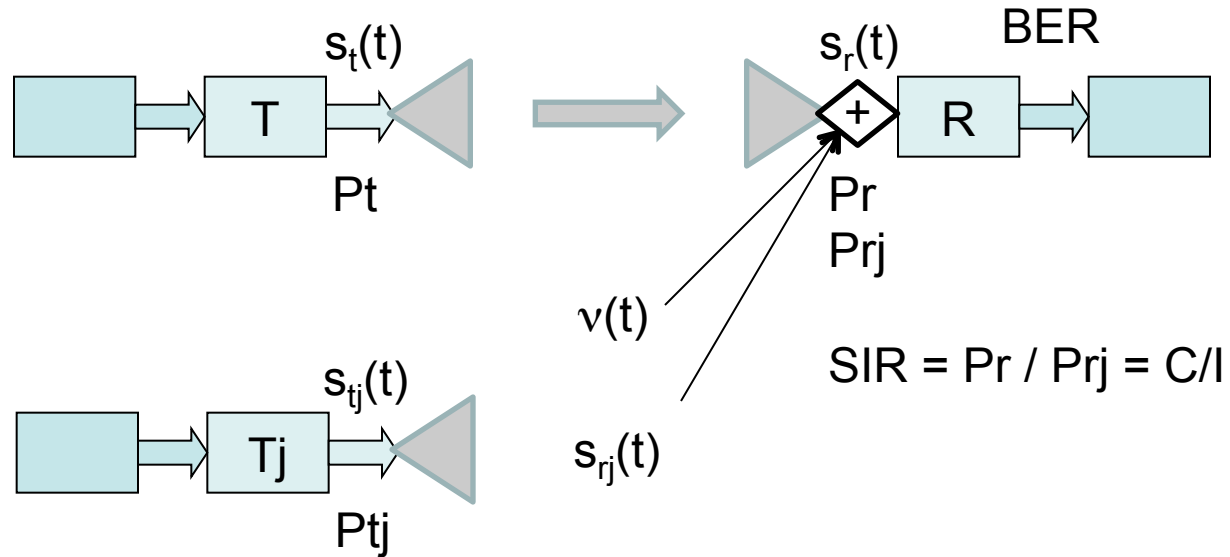

$$s_{mj}(t) = V_j * v_{pj}(t - \tau_j) * \cos(2\pi f_c(t - \tau_j) - \phi_j) - V_j * v_{qj}(t - \tau_j) * \sin(2\pi f_c(t - \tau_j) - \phi_j)$$

$$v_{pj}(t) = \sum a_{pnj} g(t - nT) \quad v_{qj}(t) = \sum a_{qnj} g(t - nT)$$

**Demodulation is linear**

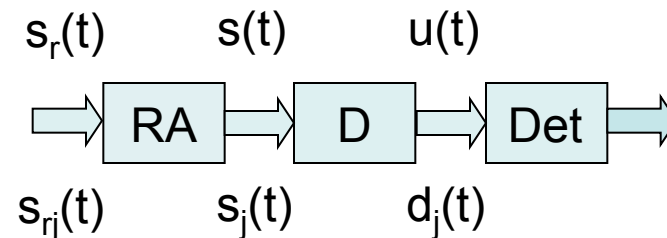

# Link Performance of M-QASK with Interference

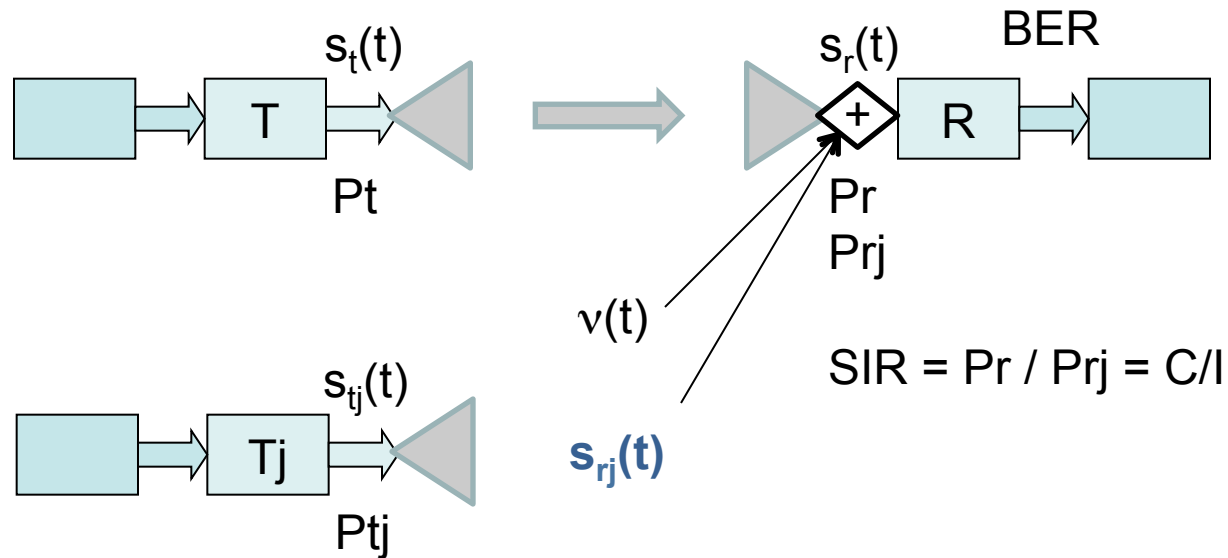

Assumptions: perfect frequency synchronisation (coherent detection)  
 perfect time synchronisation  
 no inter-symbol interference  
 symbol-by-symbol threshold based detection  
 Gray encoding

Math. derivation

→ BER = BER (SNR, SIR) **under Gaussian assumption**

# Link Performance of M-QASK with Interference

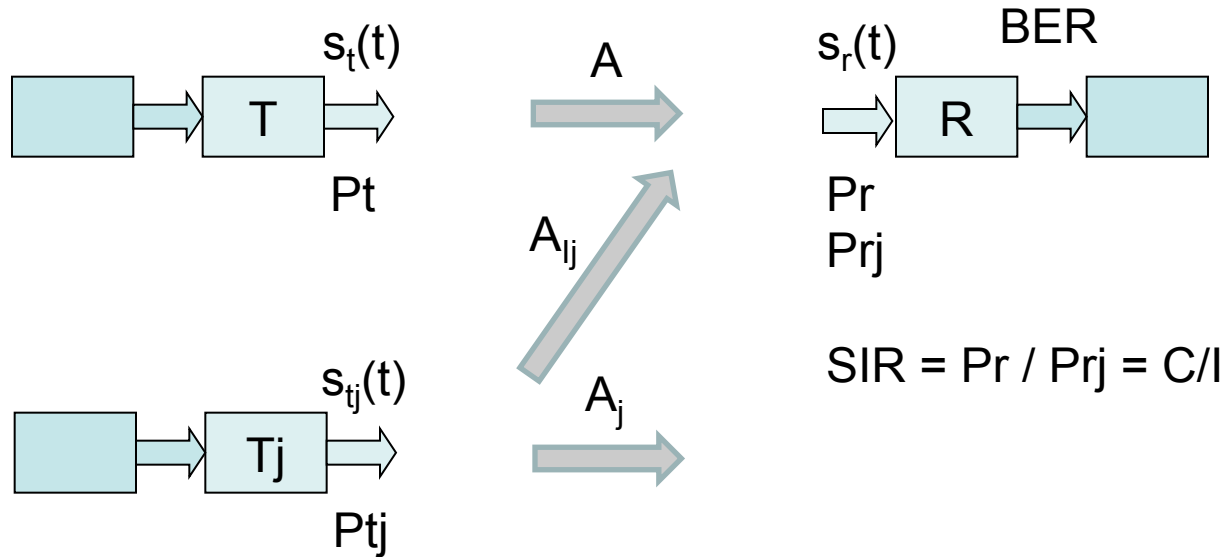

Noise-Limited System:

$$BER = [(L-1)/(L \log_2(L))] \operatorname{erfc}(\sqrt{[\gamma \log_2(L) / (L-1)^2]}) \quad L = \sqrt{M}$$

With interference:

$$BER = [(L-1)/(L \log_2(L))] \operatorname{erfc}(\sqrt{[1 / [ (L-1)^2 / \gamma \log_2(L) + 2 (L^2-1) (1 - r/4) / 3 C/I ] ]}) \quad L = \sqrt{M}$$

# Link Performance of M-QASK with Interference

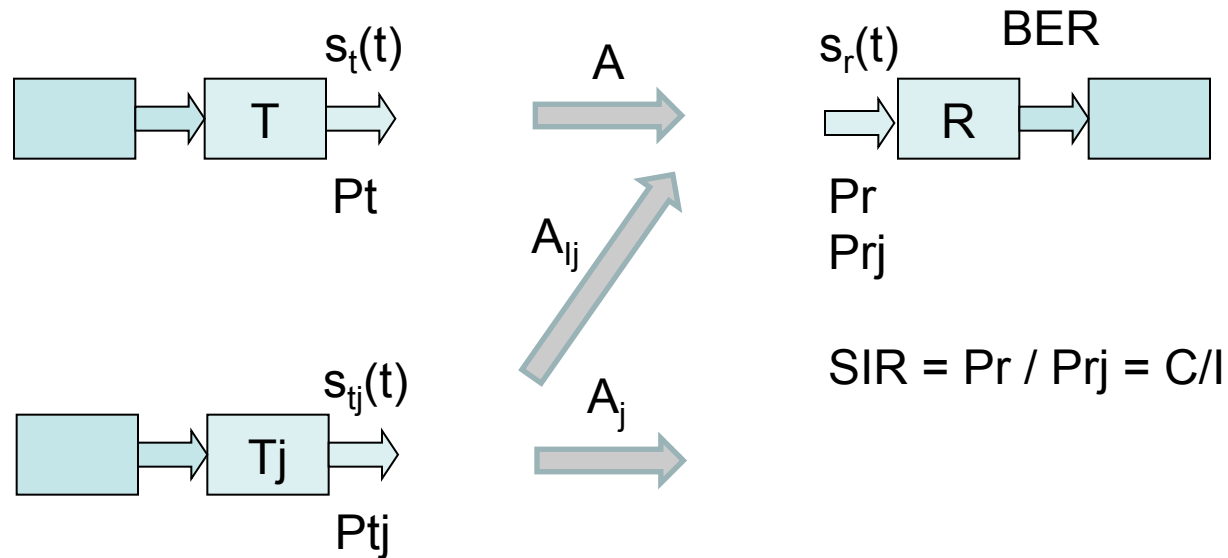

Noise-Limited System:

$$BER = [(L-1)/(L \log_2(L))] \operatorname{erfc}(\sqrt{[\gamma \log_2(L) / (L-1)^2]})$$

$$L = \sqrt{M}$$

Interference-Limited System:

$$BER = [(L-1)/(L \log_2(L))] \operatorname{erfc}(\sqrt{[3 C/I / 2 (L^2-1) (1 - r/4)]})$$

$$L = \sqrt{M}$$

# Link Performance of M-QASK with Interference

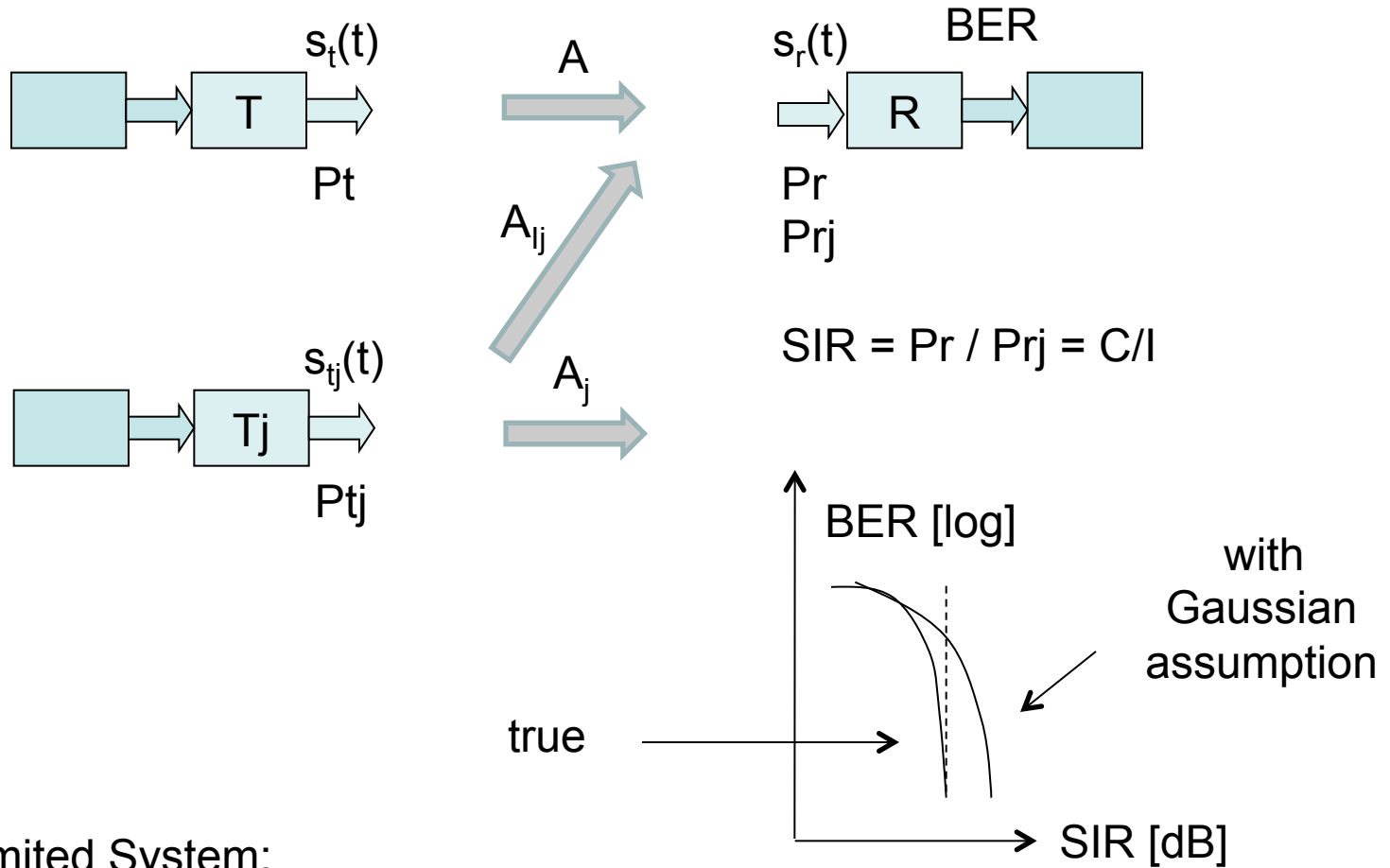

Interference-Limited System:

$$BER = \left[ \frac{L-1}{L \log_2(L)} \right] \operatorname{erfc} \left( \sqrt{\frac{3 C/I}{2 (L^2-1) (1 - r/4)}} \right)$$

$$L = \sqrt{M}$$

# Link Performance of M-QASK with Interference

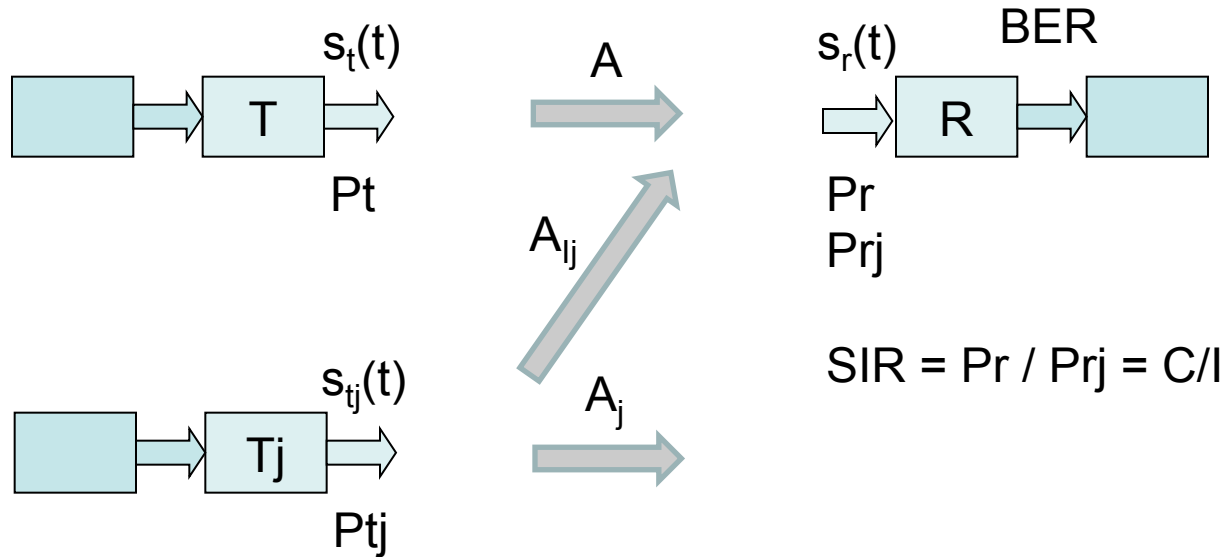

$P_r$  and SIR depend on channel gain through the PC technique:

IB-PC:	$SIR = SIR_o$	constant
FC-PC:	$SIR = P_{ro} A_{ij} / P_{ro} A_j = A_{ij} / A_j$	variable
No PC:	$SIR = P_t A_{ij} / P_{tj} A = A_{ij} / A$	variable

The expression of BER does not depend on PC. The SIR does.

## Exercise DTI#1

**A radio system uses QPSK over an AWGN channel with ARQ. The system uses raised cosine filtering with roll-off factor 0.35. Data blocks have size 1 Kbytes. The bit rate is 54 Mbit/s. The channel bandwidth is 22 MHz, centred at carrier frequency 2.45 GHz. The (monolateral) noise density power is  $10^{-20}$  W/Hz. Determine the protection ratio [dB] defined as the minimum SIR ensuring BLER=0.01 in interference limited conditions, under Gaussian assumption. Is it larger or smaller than the required SNR in noise limited conditions?**

**Compute the protection ratio for 16-QASK and 64-QASK under same conditions, and compare it with the required SNR in noise limited conditions.**

---



## Exercise DTI#2

**A radio system uses QPSK over an AWGN channel with ARQ. The system uses raised cosine filtering with roll-off factor 0.35. Data blocks have size 1 Kbytes. The bit rate is 54 Mbit/s. The channel bandwidth is 22 MHz, centred at carrier frequency 2.45 GHz. The (monolateral) noise density power is  $10^{-20}$  W/Hz. Determine the protection ratio [dB] defined as the minimum SIR ensuring BLER=0.01 in interference limited conditions, under Gaussian assumption.**

**Determine the minimum SIR ensuring BLER=0.01 with values of SNR equal to 12 dB, 11 dB, 10 dB.**

---

# Link Performance of M-QASK with Interference

## Mathematical Derivation

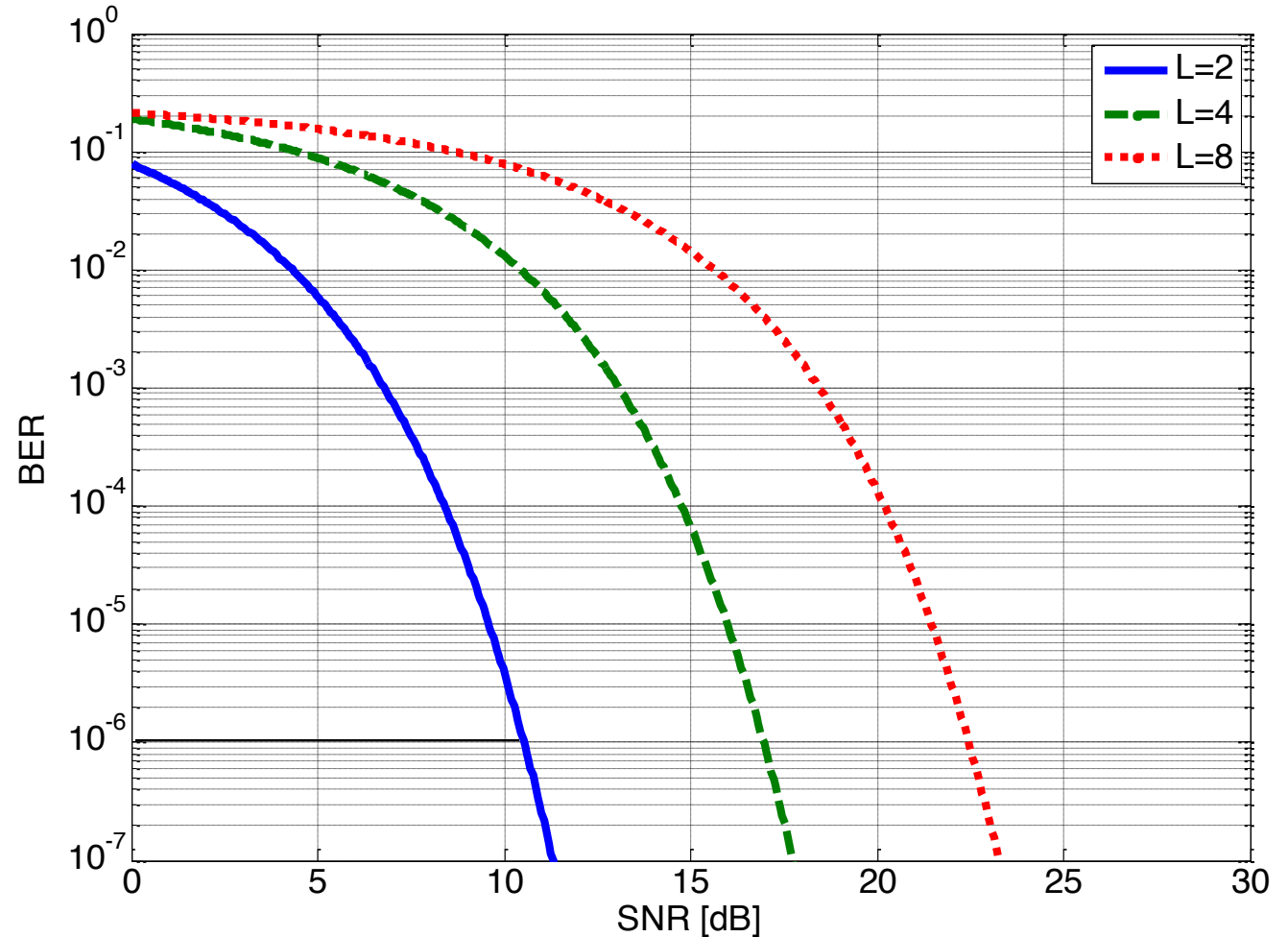

# Link Performance of M-QASK with Interference

## Mathematical Derivation

$r = 0.35$

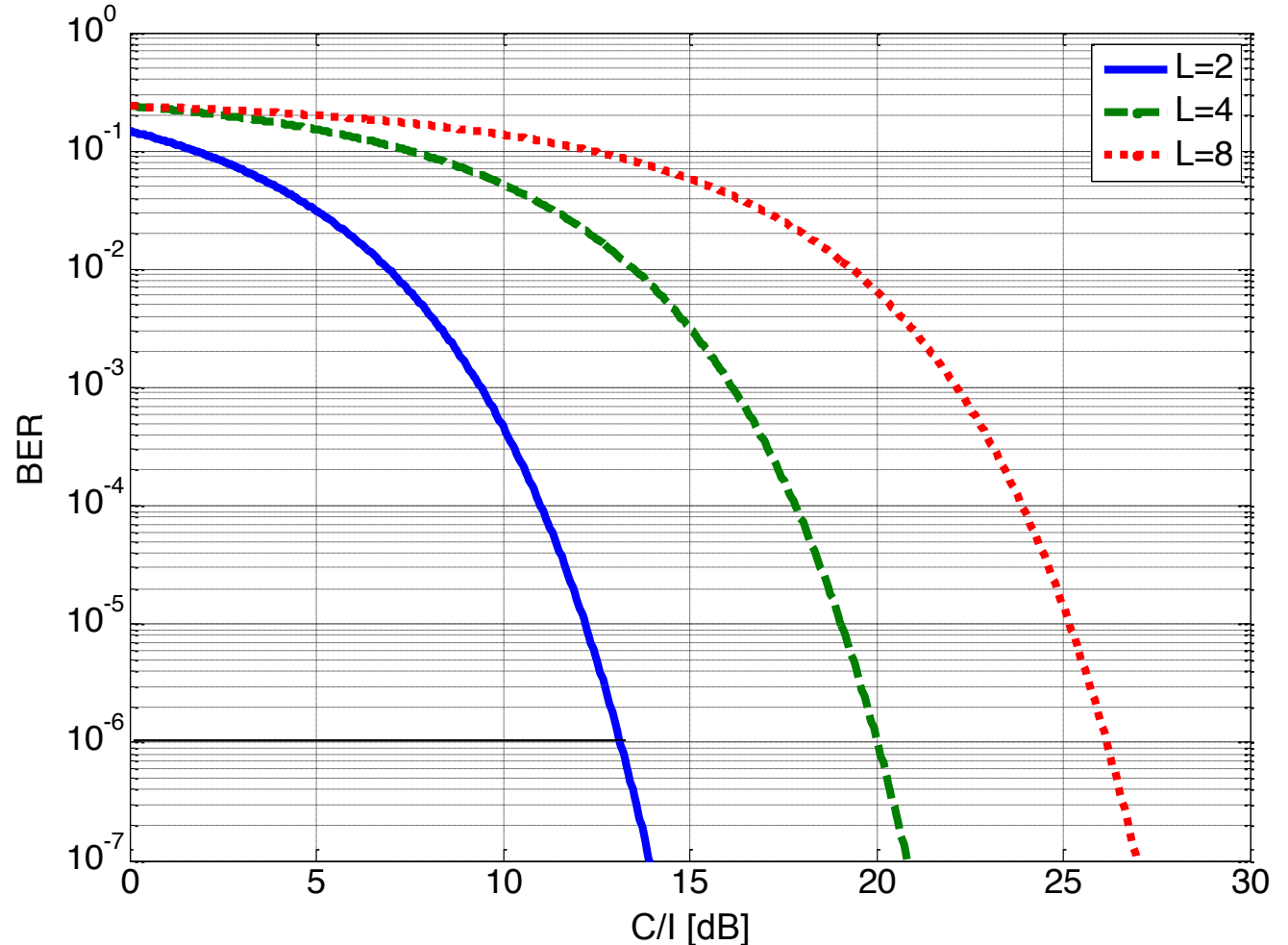

# Link Performance of M-QASK with Interference

## Mathematical Derivation

$r = 0.35$

$L = 2$

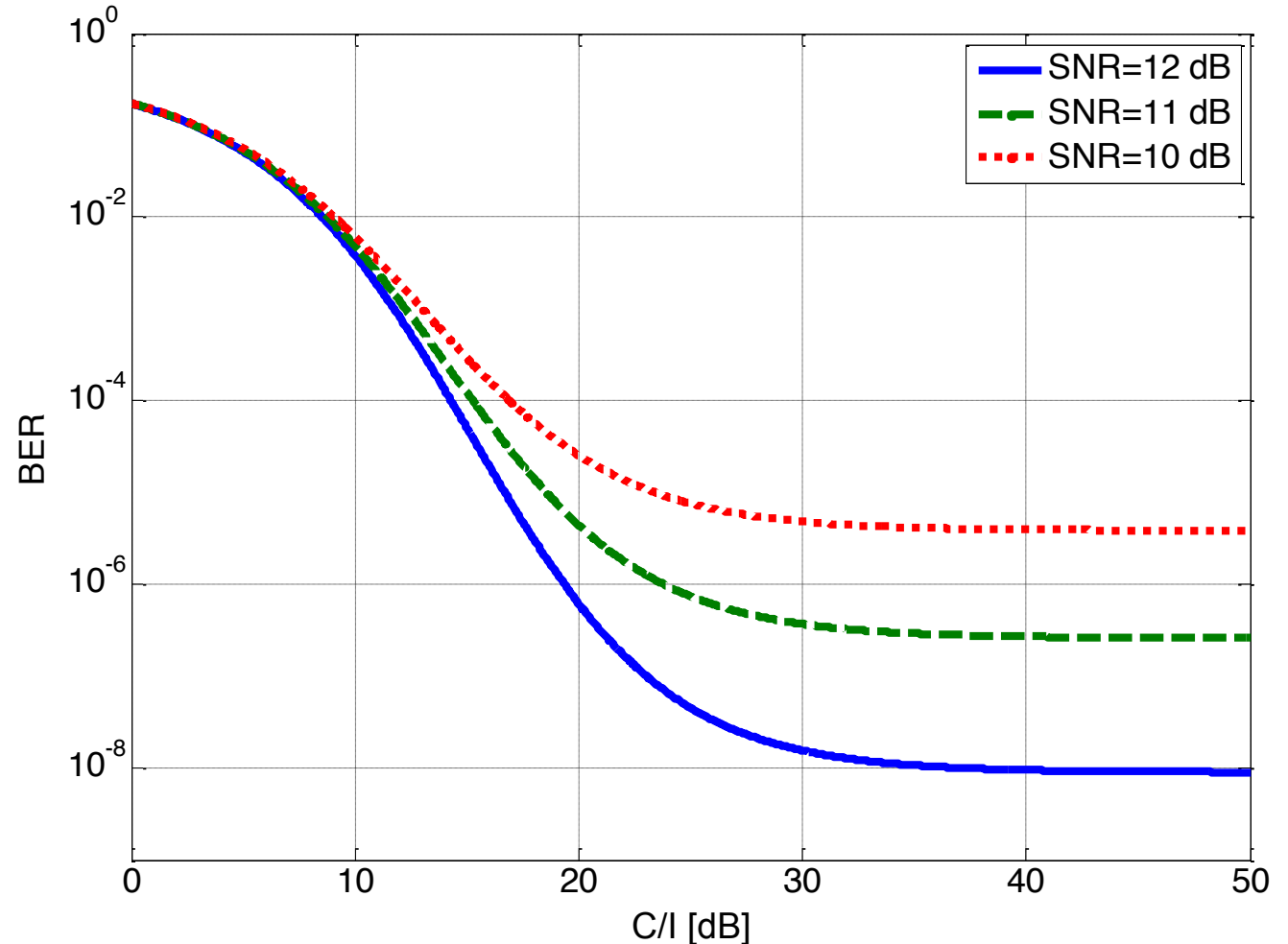

# Link Performance of M-QASK with Interference

Mathematical Derivation  
ARQ, 10KB

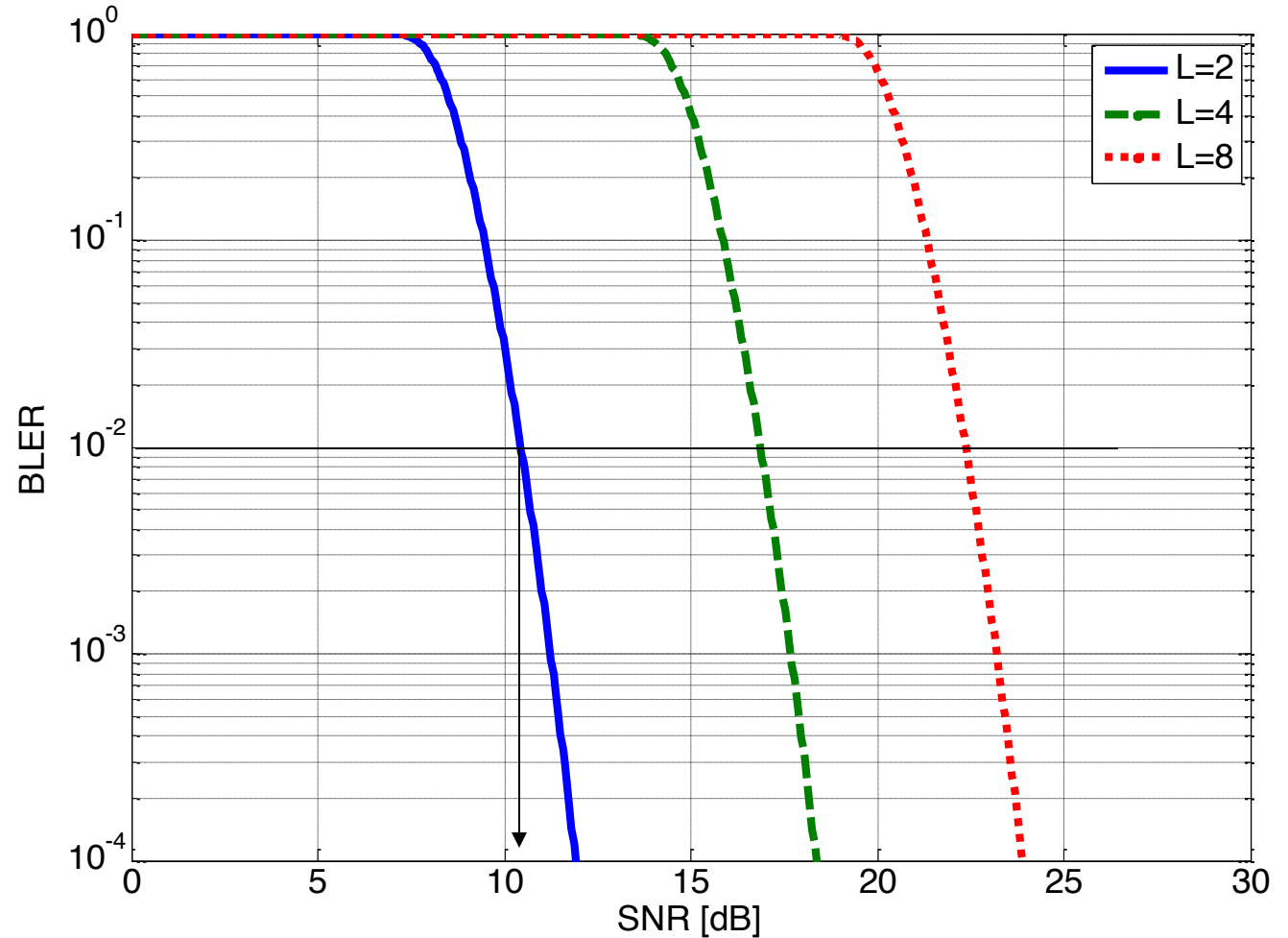

# Link Performance of M-QASK with Interference

## Mathematical Derivation

ARQ, 10KB,  $r = 0.35$

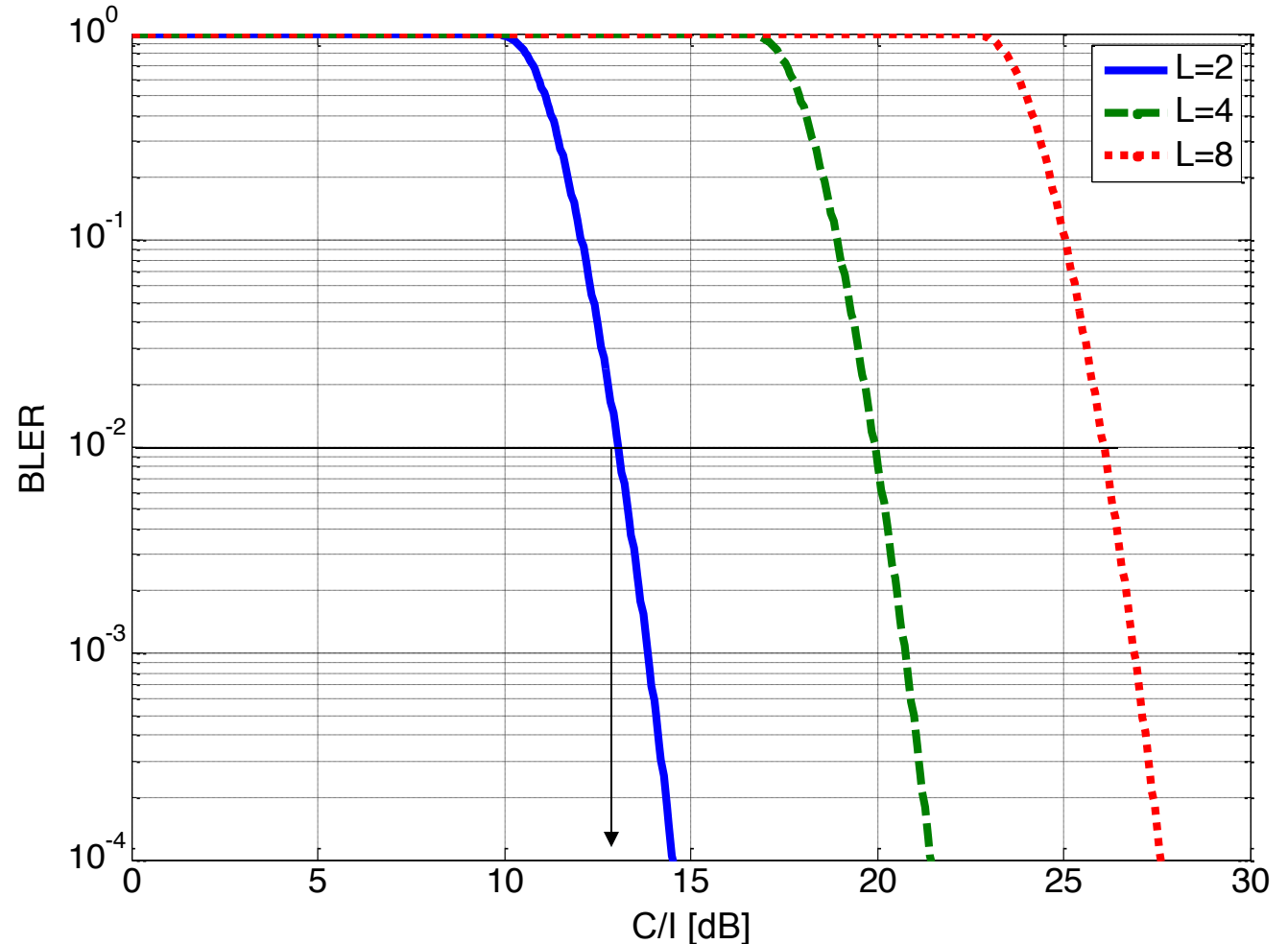

# Link Performance of M-QASK with Interference

## Mathematical Derivation

ARQ, 10KB,  $r = 0.35$

$L = 2$

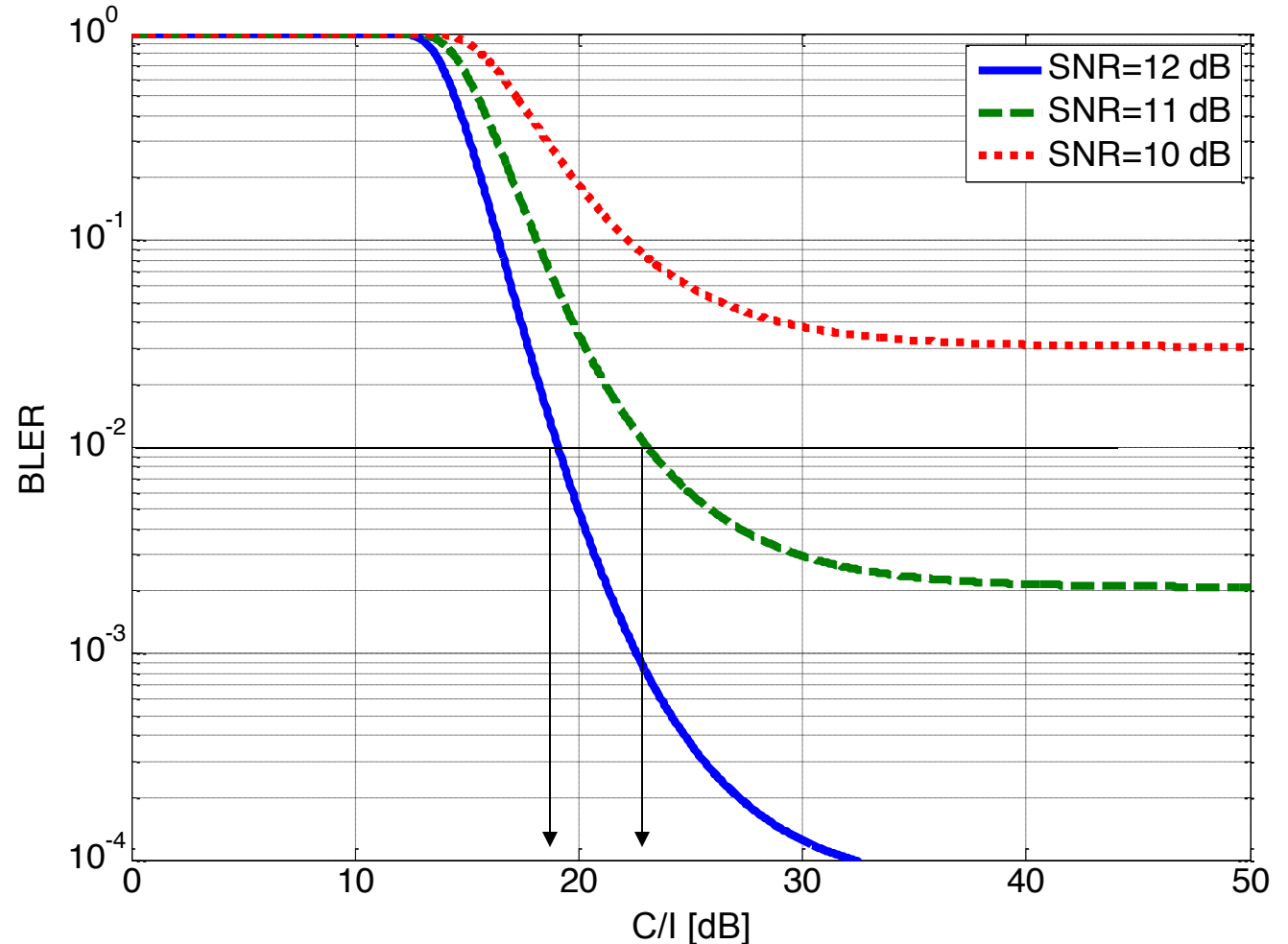

# 6. Capture Effect



# Capture Effect

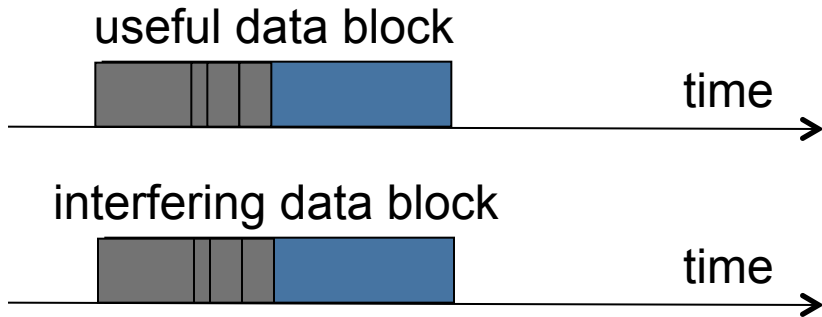
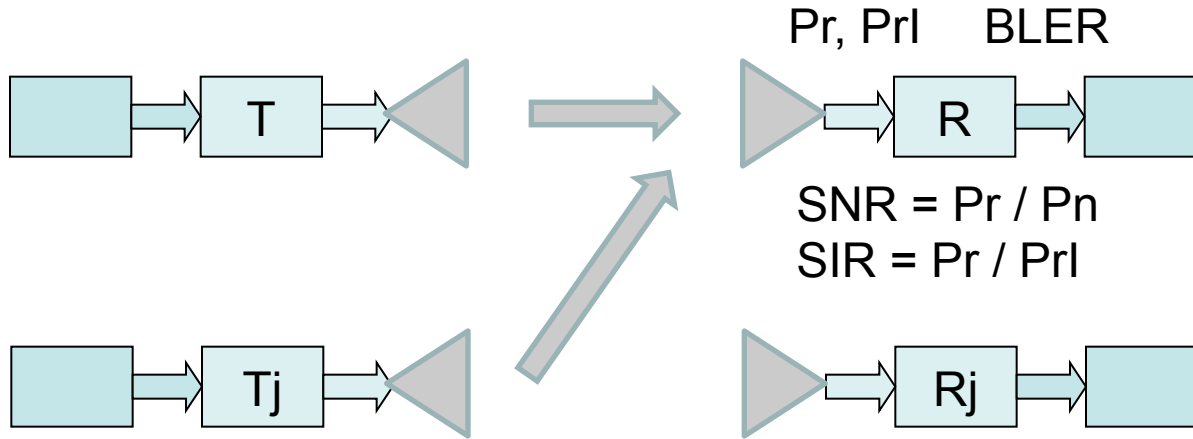

Data blocks transmitted simultaneously on the same frequencies

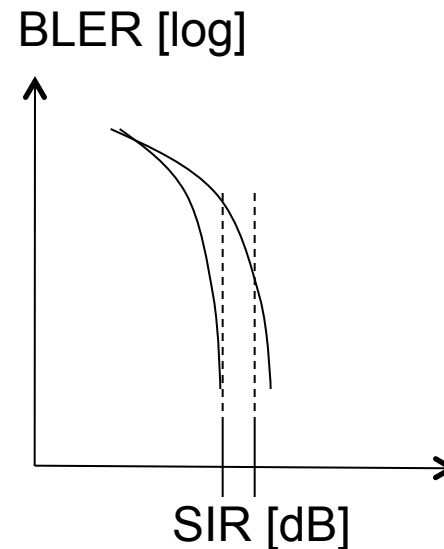

# Capture Effect

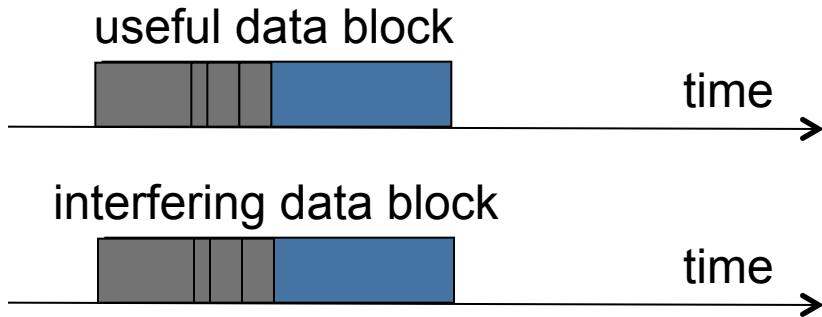
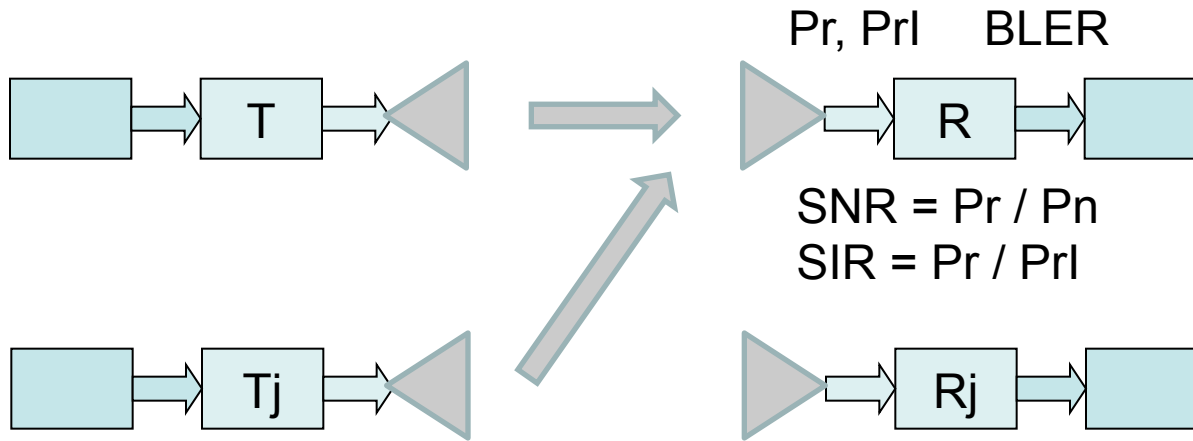

Data blocks transmitted simultaneously on the same frequencies

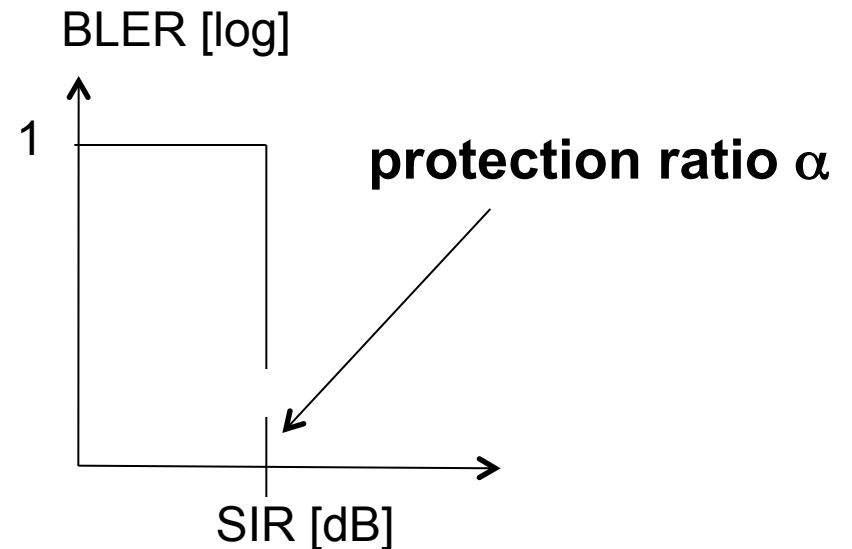

# Capture Effect

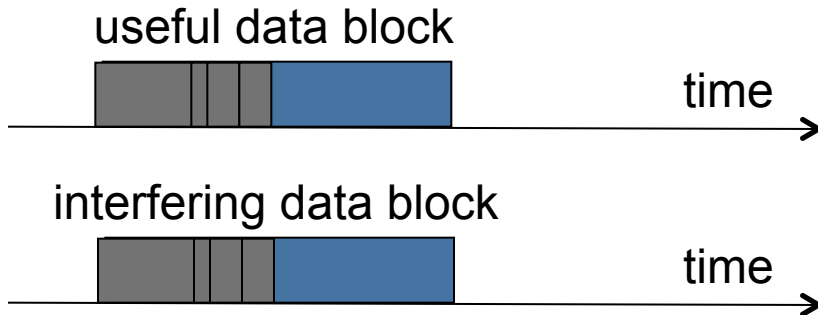
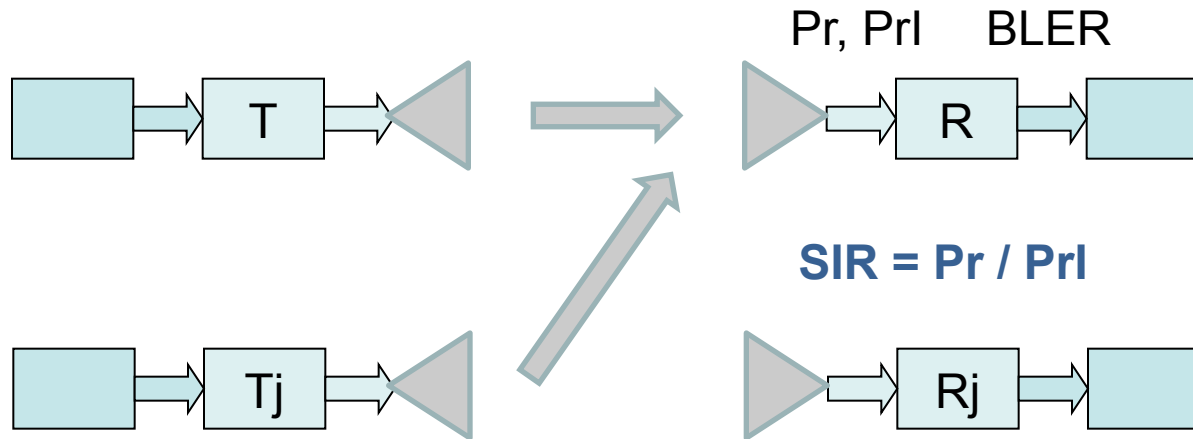

**If  $SIR > \alpha$  then data block is captured by receiver, otherwise lost**  
**Capture Probability:  $P_c = \text{Prob} [ SIR > \alpha ] \rightarrow$  pdf of SIR is needed**

# Capture Effect

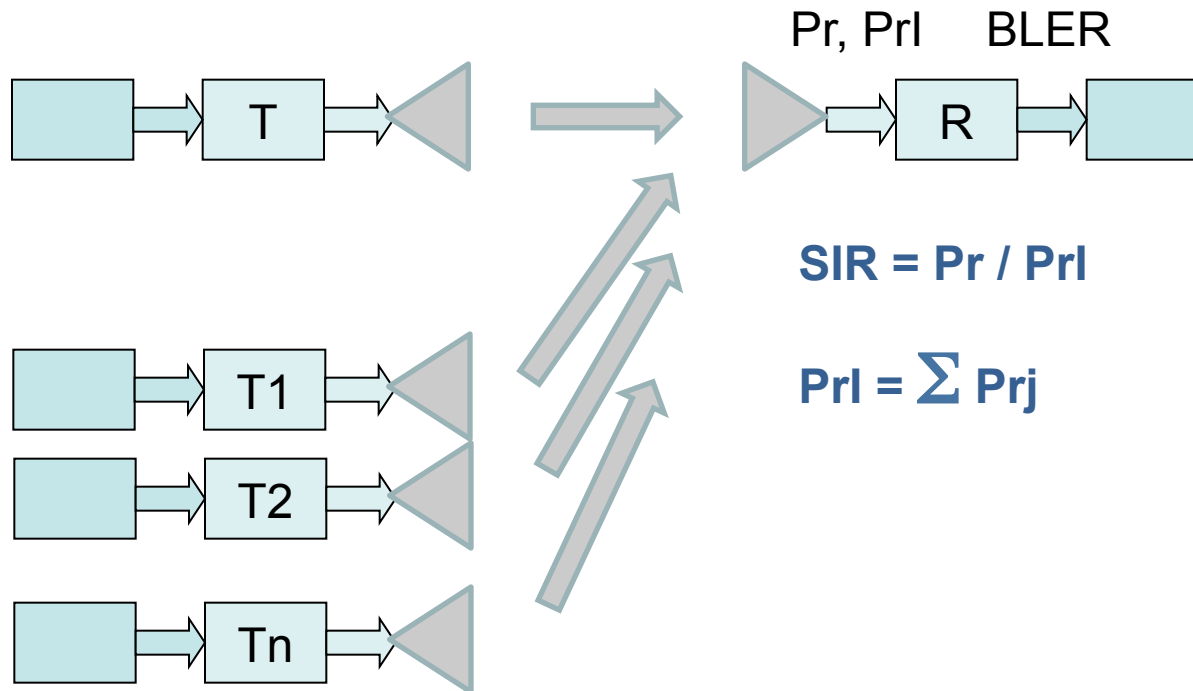

**With multiple interferers, the interference power is the sum of powers**

**If  $SIR > \alpha$  then data block is captured by receiver, otherwise lost**

**Capture Probability:  $P_c = \text{Prob} [ SIR > \alpha ] \rightarrow$  pdf of SIR is needed**

# Capture Effect

Example: BPSK with matched filter

Theoretical

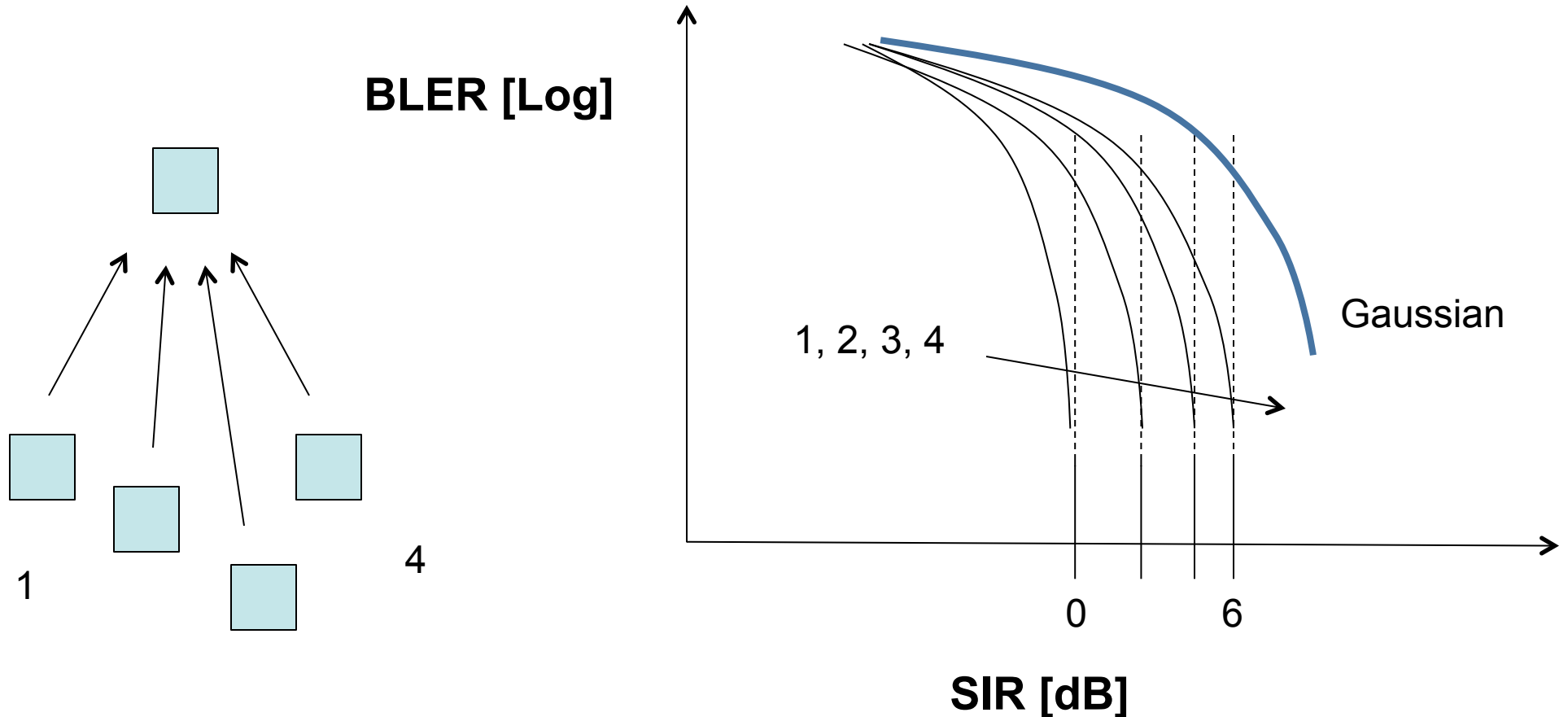

# Capture Effect

Example: 802.15.4

Measurements

1 - BLER

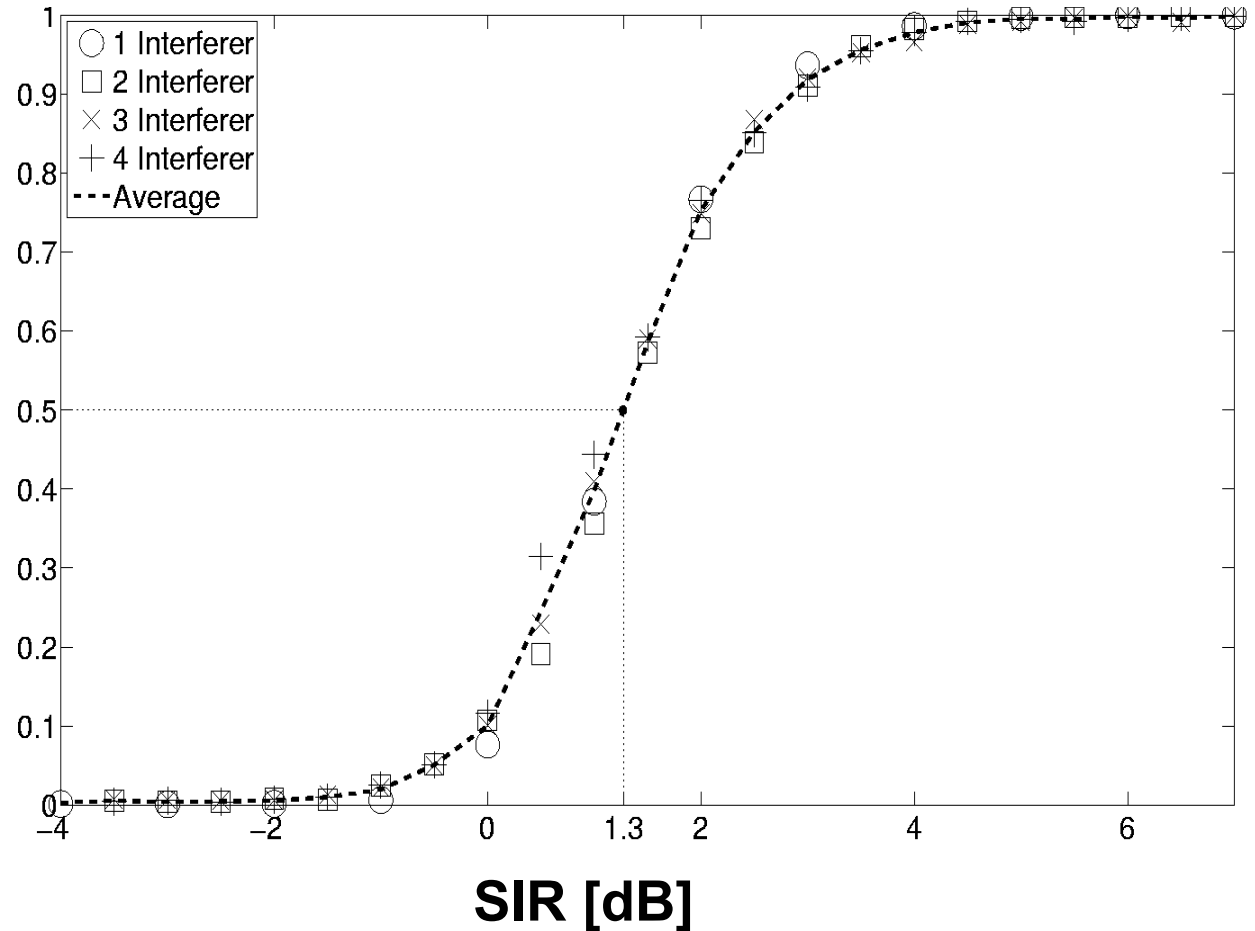
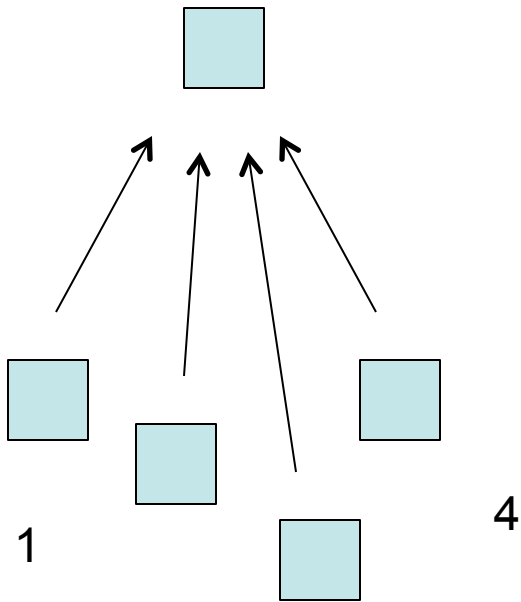

# Capture Effect

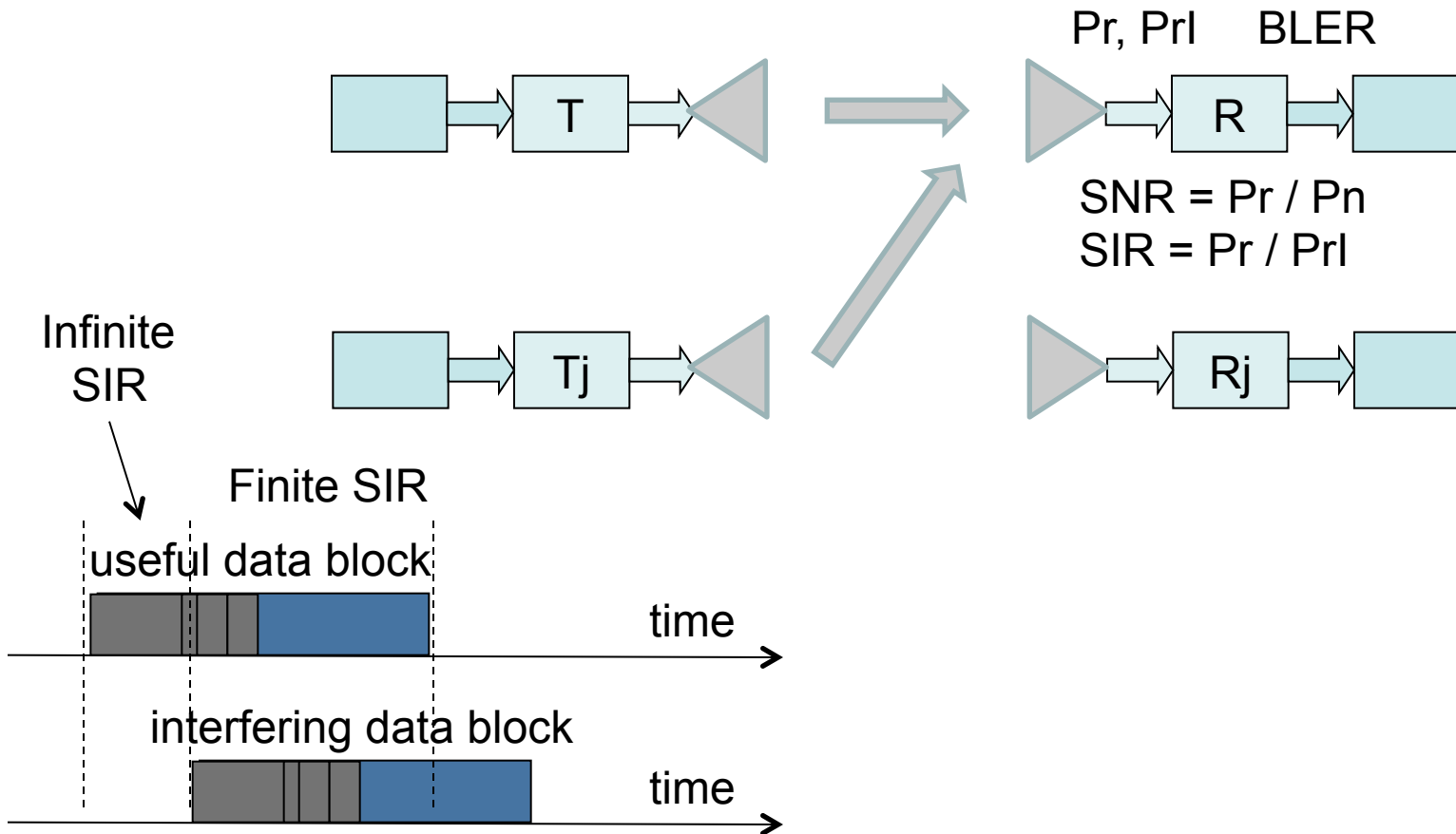

Data blocks transmitted *partially* simultaneously on the same frequencies



The minimum level of SIR is considered

# Capture Effect

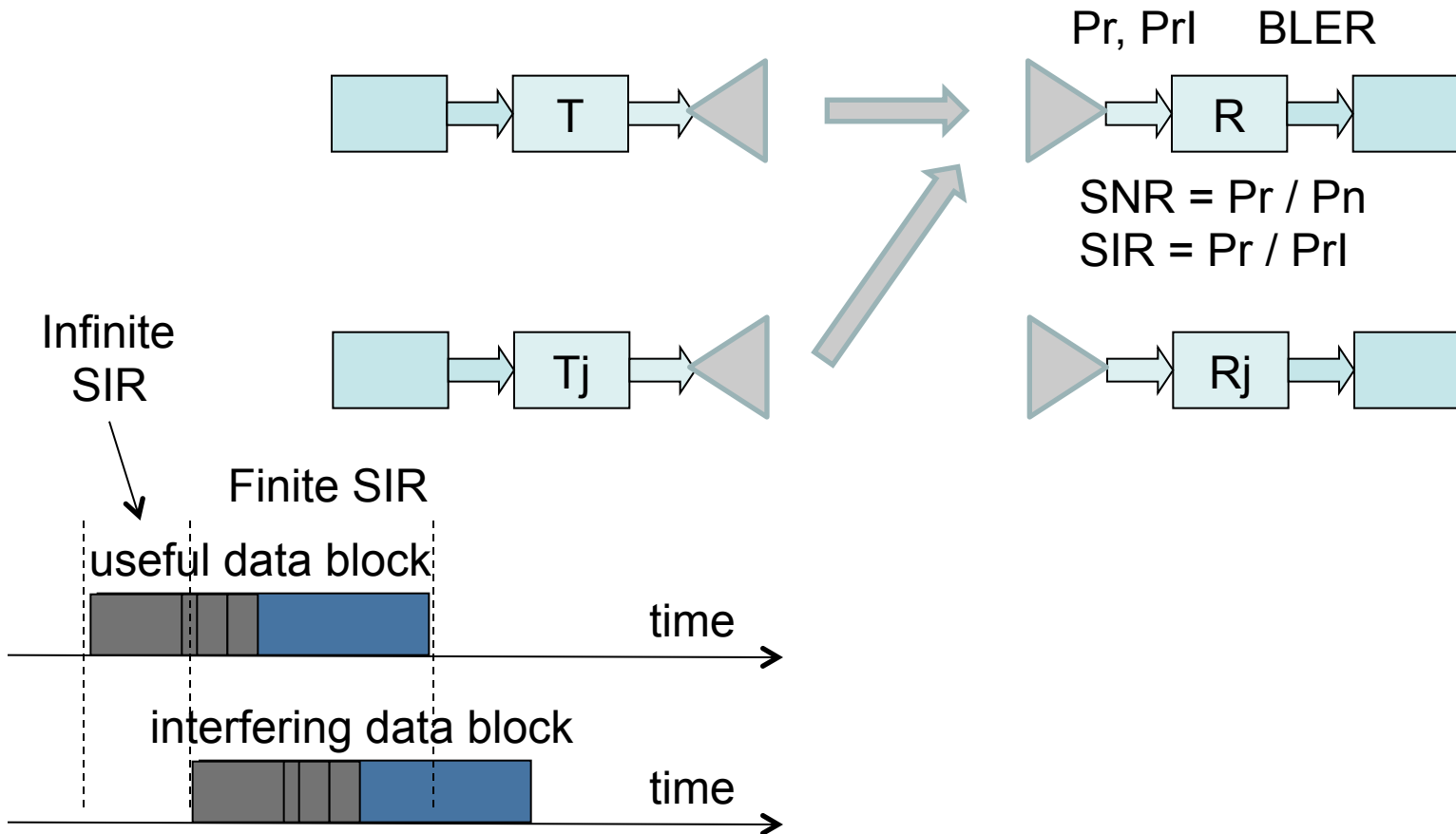

**If  $SIR > \alpha$  then data block is captured by receiver, otherwise lost**  
**Capture Probability:  $P_c = \text{Prob} [ SIR_{min} > \alpha ]$**



# Capture Effect

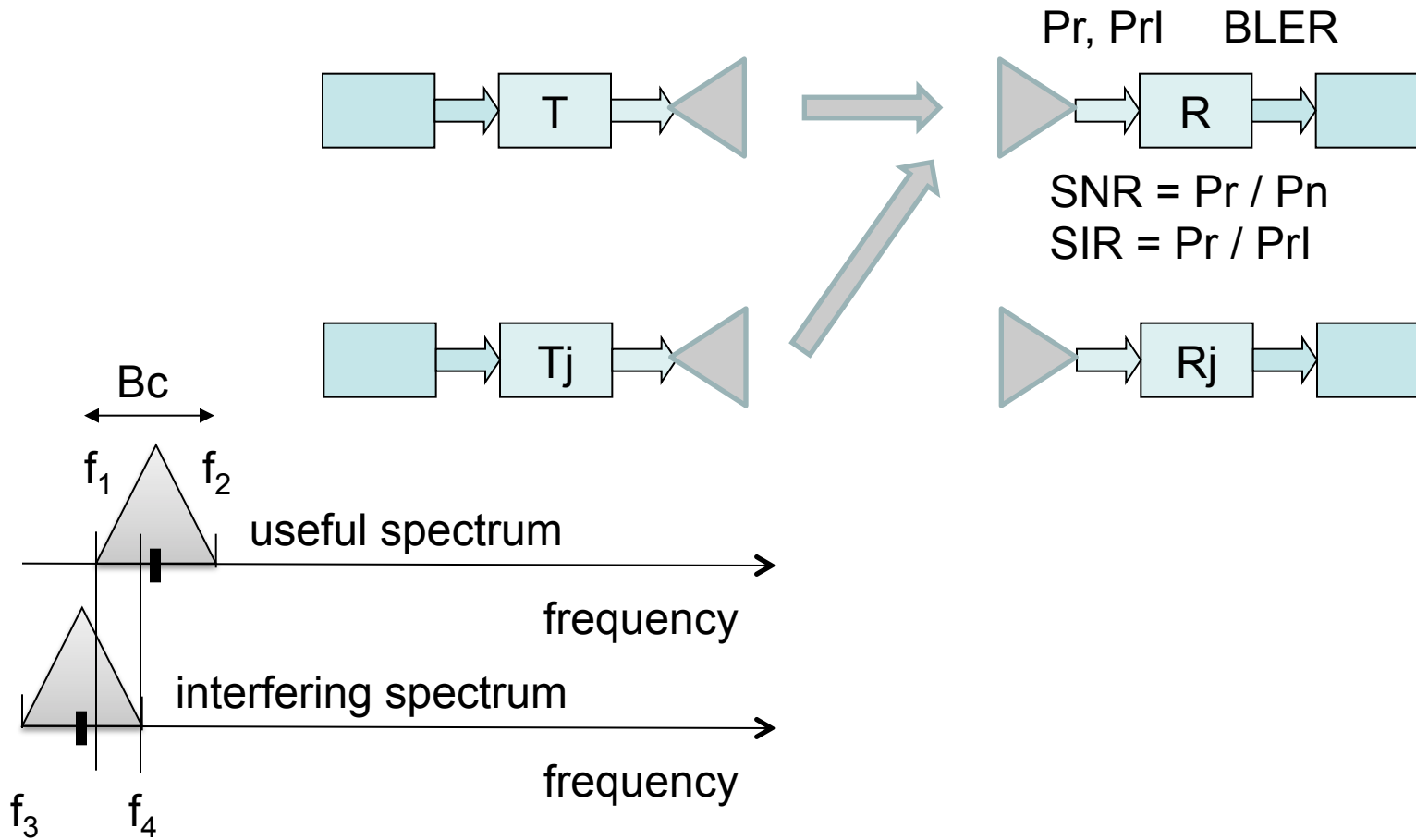

**data blocks transmitted simultaneously  
*partially* on the same frequencies**

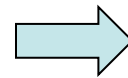

**The C/I  
is considered**

# Capture Effect

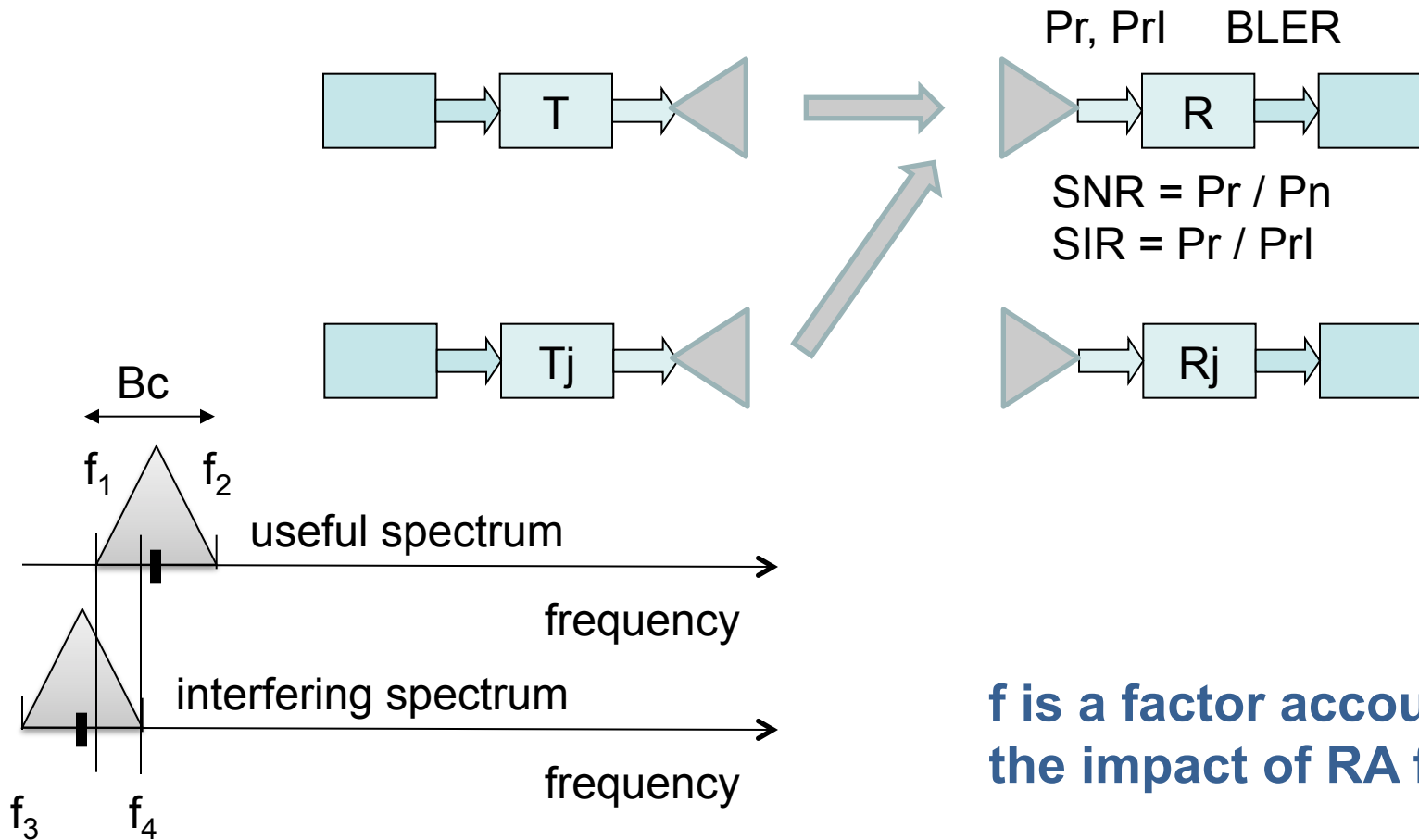

**f is a factor accounting for the impact of RA filtering**

**If  $SIR > \alpha$  then data block is captured by receiver, otherwise lost**

**Capture Probability:  $P_c = \text{Prob} [ C/I > \alpha ]$  where  $C/I = SIR * f$  with  $f > 1$**

## Inquiry Based Session

**Assume multiple nodes have to transmit to a given sink node.  
Positions are known, received powers are known.  
How can we ensure capture if the nodes need to transmit  
simultaneously towards a given receiver?  
(make the sink node as complex as you want)**

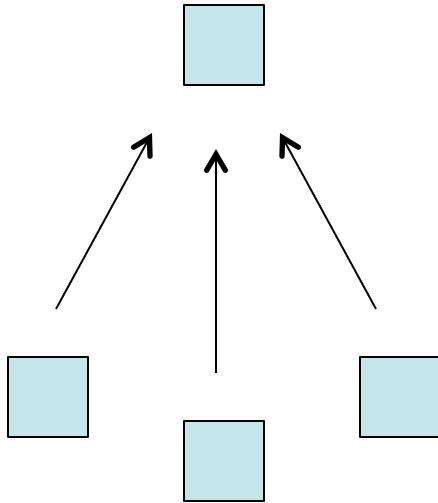

# Inquiry Based Session

**What is the underlying consideration behind the assumption that the overall interference power is the sum of powers?**

**Does the consideration always hold?**

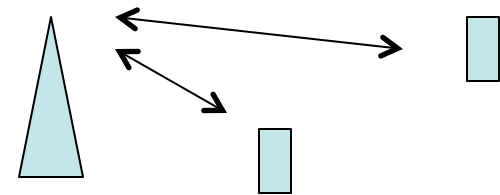
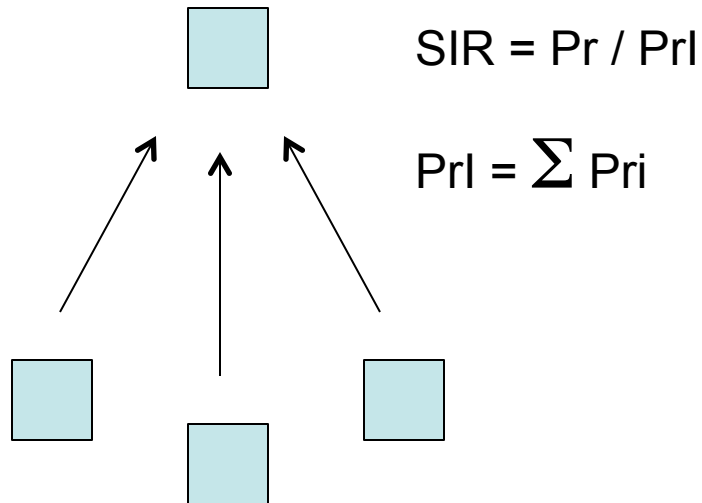

# 7. Direct Sequence Spread Spectrum with Interference

# Direct Sequence Spread Spectrum with Interference

Unique code (sequence of binary chips of length  $Q$ ) assigned to link.

Code used to generate bimodal ( - 1; + 1 ) PAM signal  $c(t)$

with rate  $R_c = R_s * P$  where  $P \gg 1$  ( $P = Q$ );

$c(t)$  multiplies the narrowband signal carrying the data.

At the receiver side multiplication again for the same PAM signal  $c(t)$ .

DSSS can be applied to any modulation format:

here, we consider BPSK.

---

# Direct Sequence Spread Spectrum with Interference

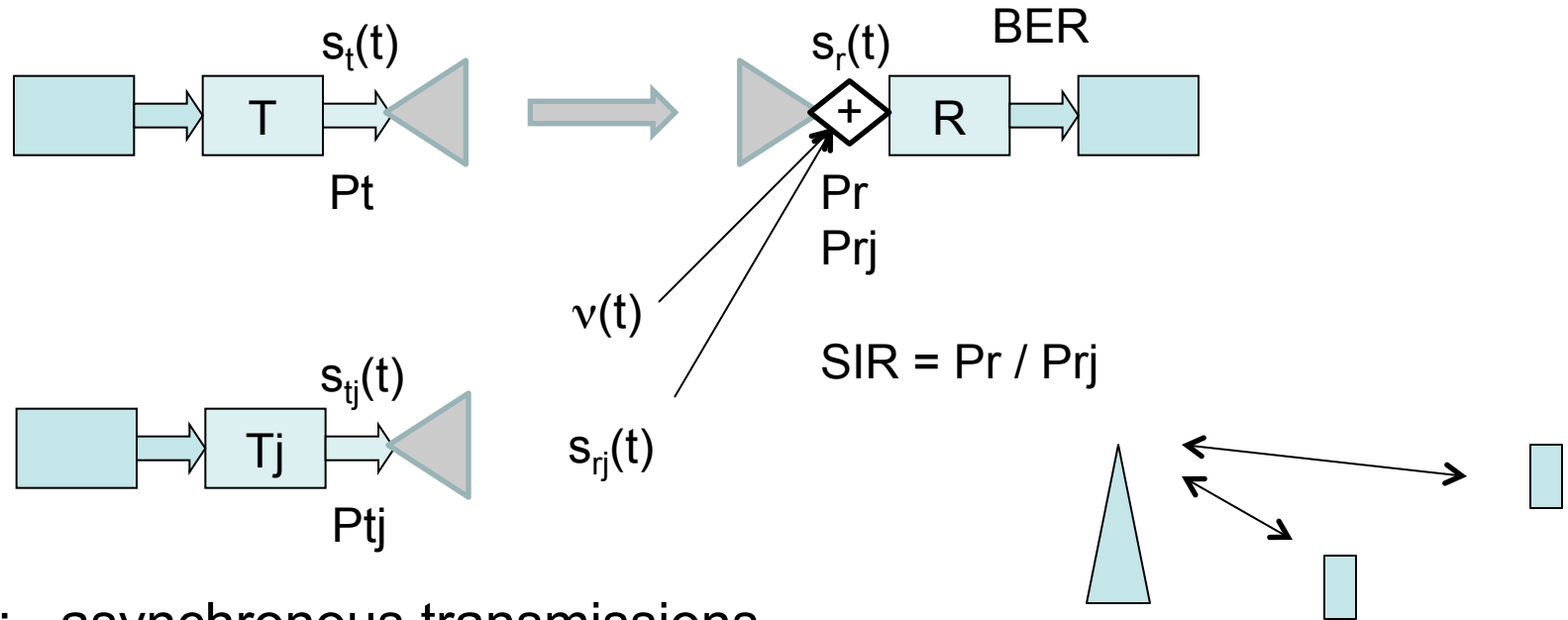

Assumptions: asynchronous transmissions

**Pseudo Noise chip sequence with  $P \gg 1$**

→  $BER = BER(SNR, SIR \cdot P)$  under Gaussian assumption

Math. derivation

**P is also said processing gain.**

# 8. Link Performance with Fading and Interference



# Link Performance with Fading and Interference

**Human – oriented applications:**      **BLER<sub>a</sub> = Long term average BLER**

$$\begin{aligned} \text{BLER}_a &= E_{\text{SNR}} E_{\text{SIR}} [\text{BLER}(\text{SNR}, \text{SIR})] = g(\text{SNR}_a, \text{SIR}_a) \\ &= E_{\text{Pr}} E_{\text{PrI}} [\text{BLER}(\text{Pr}, \text{PrI})] \end{aligned}$$

**Machine – type applications:**      **P<sub>out</sub> = Link Level Outage Probability**

$$\begin{aligned} P_{\text{out}} &= \text{Prob} [ \text{BLER} > \text{BLER}^* ] \\ &= \text{Prob} [ \text{SNR} < \text{SNR}^* \text{ OR } \text{SIR} < \text{SIR}^* ] = P_{\text{out}}(\text{SNR}_a, \text{SIR}_a) \\ &= \text{Prob} [ \text{Pr} < \text{Pr}^* \text{ OR } \text{SIR} < \text{SIR}^* ] \end{aligned}$$

# Link Performance with Fading and Interference

What is the pdf of  $P_{rl}$  ?

What is the pdf of SIR ?

Since  $P_{rl}$  is the sum of  $P_{rj}$ , the pdf of  $P_{rl}$  is the convolution of the pdfs of  $P_{rj}$ ,  $j = 1, \dots, N_{int}$ .

Assume  $SIR \gg 1$  (the situation of interest). Therefore  $P_{ra} \gg P_{rla} > P_{rja}$  .

Assume Rayleigh fading: variance is equal to the square of the mean.  
Therefore  $\sigma_{Pr}^2 \gg \sigma_{Prj}^2$  . So, **let's neglect the randomness of  $P_{rj}$**  ( $\sigma_{Prj}^2 = 0$ ).

Then,  $SIR = Pr / P_{rl} \approx Pr / E[P_{rl}]$  where  $E[P_{rl}] = \sum E[P_{rj}] = \sum P_{rja} = N_{int} P_{rja}$  ,  
and it has pdf given by the pdf of  $Pr$  except for the constant  $N_{int} P_{rja}$  ,  
i.e. it is negative exponentially distributed with mean  $P_{ra} / N_{int} P_{rja}$  ,  
that is,  $P_{ra} / P_{rla}$  .

---

# Link Performance with Fading and Interference

What is the pdf of  $P_{rl}$  ?

What is the pdf of SIR ?

Since  $P_{rl}$  is the sum of  $P_{rj}$ , the pdf of  $P_{rl}$  is the convolution of the pdfs of  $P_{rj}$ ,  $j = 1, \dots, N_{int}$ .

Assume  $SIR \gg 1$  (the situation of interest). Therefore  $P_{ra} \gg P_{rla} > P_{raj}$ .

Assume Rayleigh fading: variance is equal to the square of the mean. Therefore  $\sigma_{Pr}^2 \gg \sigma_{Prj}^2$ . So, **let's neglect the randomness of  $P_{rj}$**  ( $\sigma_{Prj}^2 = 0$ ).

Then,  $SIR = Pr / P_{rl} \approx Pr / E[P_{rl}]$  where  $E[P_{rl}] = \sum E[P_{rj}] = \sum P_{rja} = N_{int} P_{rja}$  and it has pdf given by the pdf of  $Pr$  except for the constant  $N_{int} P_{rja}$ , i.e.

$$\xi = SIR$$

$$p_{\xi}(\xi) \approx (1/\xi_m) \exp(-\xi/\xi_m) u(\xi)$$

$$\xi_m = SIR_m = P_{ra}/P_{rla}$$

# Link Performance with Fading and Interference

## Noise limited system

$$\gamma = \text{SNR}$$

$$p_{\gamma}(\gamma) = (1/\gamma_a) \exp(-\gamma/\gamma_a) u(\gamma)$$

$$\gamma_a = \text{SNRa} = \text{Pra}/\text{NoRb}$$

$$\text{BLERa} = \text{Int} [\text{BLER}(\gamma) p_{\gamma}(\gamma) d\gamma]$$

$$\text{Pout} = 1 - \exp(-\gamma^*/\gamma_a)$$

## Interference limited system

$$\xi = \text{SIR}$$

$$p_{\xi}(\xi) \approx (1/\xi_m) \exp(-\xi/\xi_m) u(\xi)$$

$$\xi_m = \text{SIRm} = \text{Pra}/\text{Prla} \\ \neq E[\text{SIR}] = E[\text{Pr}/\text{Prl}]$$

$$\text{BLERa} \approx \text{Int} [\text{BLER}(\xi) p_{\xi}(\xi) d\xi]$$

$$\text{Pout} \approx 1 - \exp(-\xi^*/\xi_m)$$

# Link Performance with Fading and Interference

Interference limited system

[Boyd, 1996]

$$P_{out} < 1 - \exp(-\xi^*/\xi_m)$$

$$P_{out} > 1 / (1 + \xi_m/\xi^*)$$

Upper Bound  
Lower Bound

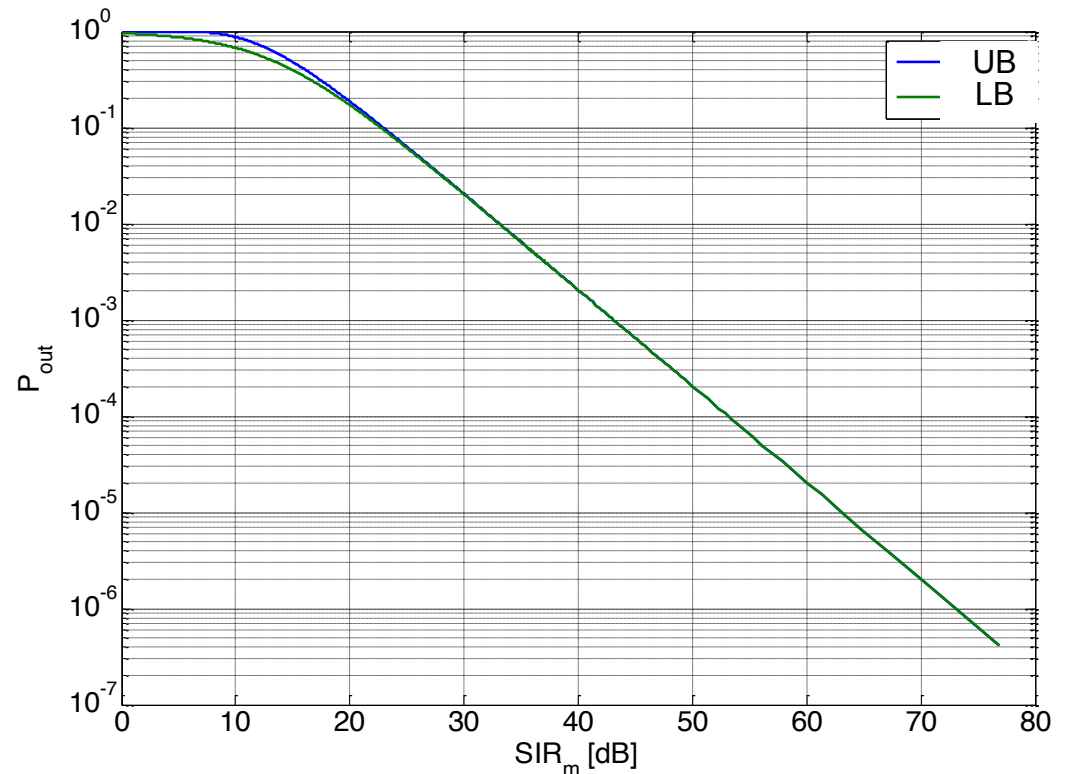

## Exercise DTI#3

**A radio network uses QPSK over an AWGN channel with ARQ. The system uses raised cosine filtering with roll-off factor 0.35. Data blocks have size 1 Kbytes. The bit rate is 54 Mbit/s. The channel bandwidth is 22 MHz, centred at carrier frequency 2.45 GHz. The (monolateral) noise density power is  $10^{-20}$  W/Hz.**

**Under free space conditions, with unitary antenna gains and connection losses, transmit powers set at 20 dBm, the network is composed of two simultaneously transmitting links. The first transmitter, T1, moves away from its receiver, R1, on a straight line. The second transmitter, T2, has fixed distance from R1 set at 7000 m. Compute the maximum useful distance compatible with a BLER requirement of 0.01.**

**Repeat the exercise with two interferers both located at 100 m from the useful receiver.**

---

## Exercise DTI#4

**A radio network uses QPSK over an AWGN channel with ARQ. The system uses raised cosine filtering with roll-off factor 0.35. Data blocks have size 1 Kbytes. The bit rate is 54 Mbit/s. The channel bandwidth is 22 MHz, centred at carrier frequency 2.45 GHz. The (monolateral) noise density power is  $10^{-20}$  W/Hz.**

**Under free space conditions, with unitary antenna gains and connection losses, transmit powers set at 20 dBm, the network is composed of two simultaneously transmitting links. The first transmitter, T1, moves away from its receiver, R1, on a straight line. The second transmitter, T2, has fixed distance from R1 set at 7000 m. Compute the maximum useful distance compatible with a BLER requirement of 0.01.**

**Assuming Rayleigh fading, superimposed to the received powers computed through the Friis formula, estimate the outage probability as a function of the T1-R1 distance, with a requirement on BLER of 0.01.**

# 9. Impact on Interference of Countermeasures to Fading



## Inquiry Based Session

**What among the countermeasures to fading that we discussed have any impact on the way the system works in the presence of some interferers?**

- 1. Interleaving**
  - 2. Adaptive Modulation and Coding**
  - 3. Diversity**
  - 4a. Direct Sequence SS with orthogonal codes**
  - 4b. Direct Sequence SS with PN codes**
  - 5. Frequency Hopping Spread Spectrum**
  - 6. Multi Carrier Modulation**
  - 7. Signal-Based Power Control**
-

## Inquiry Based Session

**What among the countermeasures to fading that we discussed have any impact on the way the system works in the presence of some interferers?**

- |   |                               |
|---|-------------------------------|
| <b>1. Interleaving</b>                              | <b>As for Noise</b>           |
| <b>2. Adaptive Modulation and Coding</b>            | <b>None (if SNR-based)</b>    |
| <b>3. Diversity</b>                                 | <b>None</b>                   |
| <b>4a. Direct Sequence SS with orthogonal codes</b> | <b>Interference Rejection</b> |
| <b>4b. Direct Sequence SS with PN codes</b>         | <b>Interference Averaging</b> |
| <b>5. Frequency Hopping Spread Spectrum</b>         | <b>Interference Averaging</b> |
| <b>6. Multi Carrier Modulation</b>                  | <b>Interference Avoidance</b> |
| <b>7. Signal-Based Power Control</b>                | <b>None</b>                   |

# 10. Power Control

## Under a Network Level View

# Network Level View

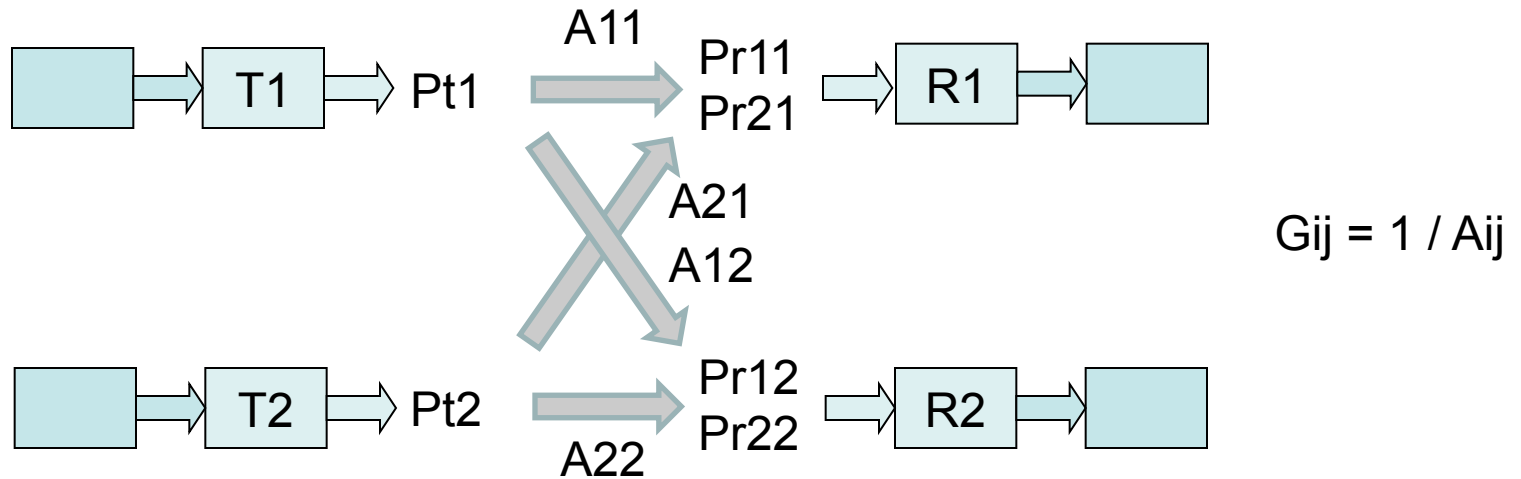

$$\begin{aligned} Pr_{11} &= Pt_1 G_{11} \\ Pr_{21} &= Pt_2 G_{21} \end{aligned}$$

$$SIR_1 = Pr_{11} / Pr_{21}$$

$$\begin{aligned} Pr_{12} &= Pt_1 G_{12} \\ Pr_{22} &= Pt_2 G_{22} \end{aligned}$$

$$SIR_2 = Pr_{22} / Pr_{12}$$

# Network Level View

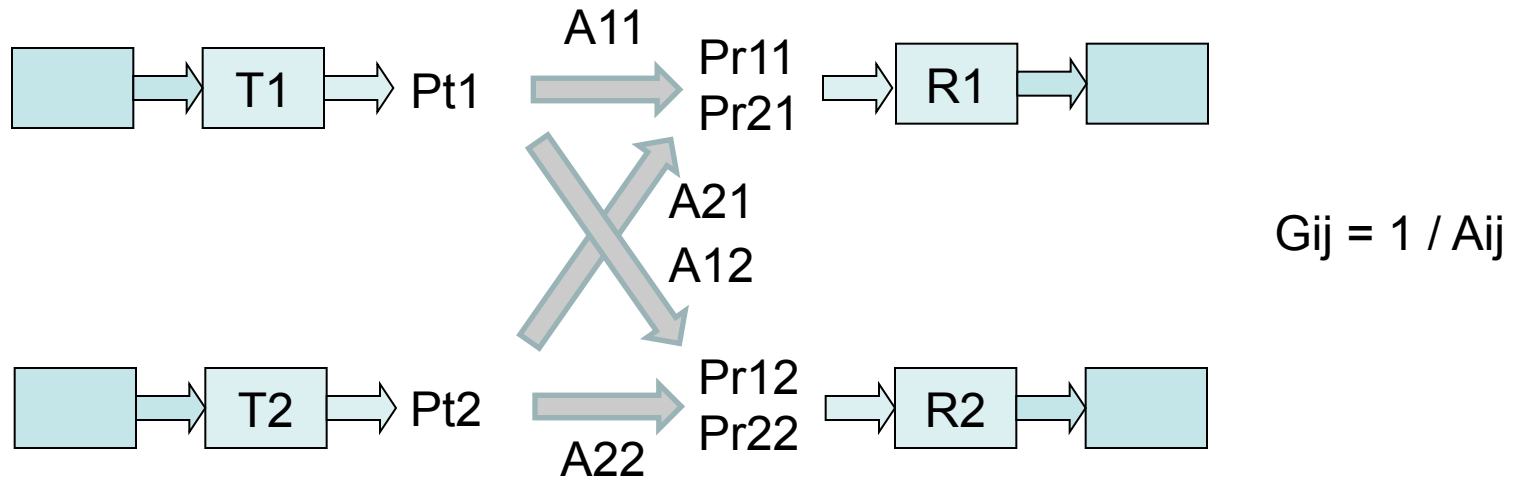

$$\begin{aligned} P_{r11} &= P_{t1} G_{11} \\ P_{r21} &= P_{t2} G_{21} \end{aligned}$$

$$SIR1 = P_{r11} / P_{r21} = P_{t1} G_{11} / P_{t2} G_{21}$$

$$\begin{aligned} P_{r12} &= P_{t1} G_{12} \\ P_{r22} &= P_{t2} G_{22} \end{aligned}$$

$$SIR2 = P_{r22} / P_{r12} = P_{t2} G_{22} / P_{t1} G_{12}$$

## Signal Based (Full Compensation) Power Control

- $P_{r11} \geq P_{ro}$
- $P_{r22} \geq P_{ro}$

→ Two independent requirements:

$$P_{t1} \geq P_{ro} / G_{11}$$

$$P_{t2} \geq P_{ro} / G_{22}$$

**SIR values are not kept under control (assume e.g. equalities hold above):**

$$SIR1 = G_{22} / G_{21}$$

$$SIR2 = G_{11} / G_{12}$$

**SB-PC requires no centralisation. No control in IL conditions.**

# Interference Based Power Control

- $SIR_1 \geq SIR_o$
- $SIR_2 \geq SIR_o$

→ Two correlated requirements:

$$P_{t1} \geq SIR_o \quad P_{t2} \frac{G_{21}}{G_{11}} = \Pi_1$$

$$P_{t2} \geq SIR_o \quad P_{t1} \frac{G_{12}}{G_{22}} \rightarrow P_{t1} \leq SIR_o^{-1} \quad P_{t2} \frac{G_{22}}{G_{12}} = \Pi_2$$

$$\rightarrow \Pi_1 \leq P_{t1} \leq \Pi_2$$

A solution exists iff

$$\rightarrow \Delta = \Pi_2 - \Pi_1 \geq 0$$
$$G_{11} \frac{G_{22}}{G_{12} G_{21}} \geq SIR_o^2$$

IB-PC requires centralisation.

# Network Level View: Down-Link Intra-Cell

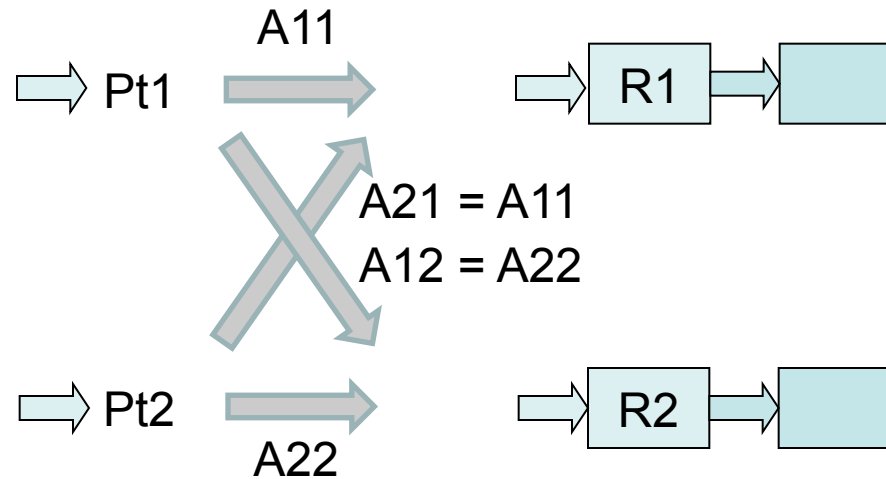
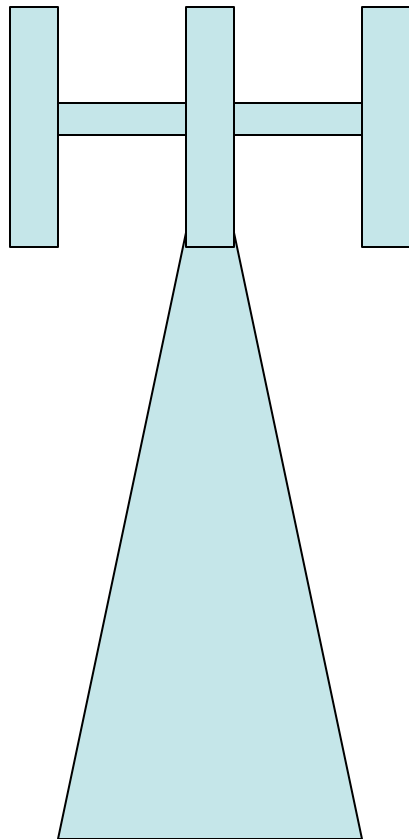

$$G_{11} G_{22} / G_{12} G_{21} \geq S I R_o^2$$

$$G_{11} G_{22} / G_{22} G_{11} \geq S I R_o^2$$

$$1 \geq S I R_o$$

Under such condition, IB-PC converges



# Network Level View: Down-Link Inter-Cell

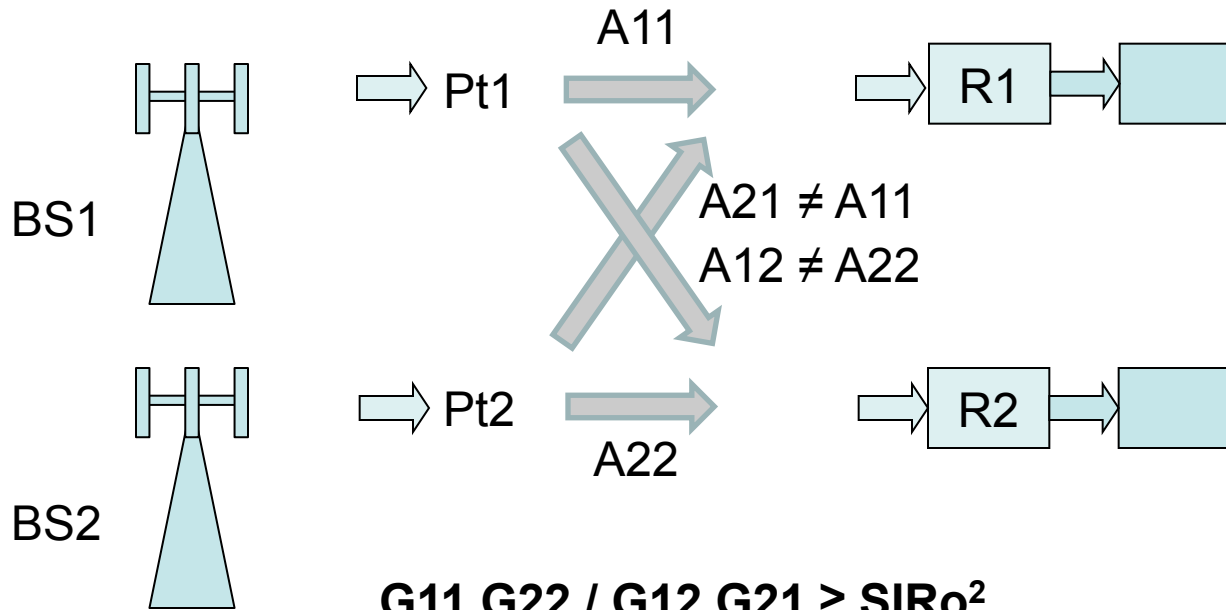

$$G_{11} G_{22} / G_{12} G_{21} \geq S I R o^2$$

**BS1 needs to be aware of measurements made by R2 (G22 and G12), managed by BS2**

**→ Centralisation is required**

## Interference and Signal Based Power Control

- $P_{t1} \geq P_{ro} / G_{11}$  (Noise Limited conditions)
- $P_{t2} \geq P_{ro} / G_{22}$  (Noise Limited conditions)
- $P_{t1} \geq S_{IRo} P_{t2} G_{21} / G_{11}$  (Interference Limited conditions)
- $P_{t2} \geq S_{IRo} P_{t1} G_{12} / G_{22}$  (Interference Limited conditions)

Iterative procedure for power assignment:

- 1) Check condition on  $\Delta$
- 2) Set  $P_{t1}$  in NL conditions
- 3) Set  $P_{t2}$  in IL conditions
- 4) Check if  $P_{t2} \geq P_{ro} / G_{22}$  ; if not, set  $P_{t2} = P_{ro} / G_{22}$
- 5) Check if  $P_{t1} \geq S_{IRo} P_{t2} G_{21} / G_{11}$  ;  
if not, set  $P_{t1} = S_{IRo} P_{t2} G_{21} / G_{11}$  and go back to step 3
- 6) Done

## Exercise DTI#5

A network is composed of two links, and an interference and signal based PC scheme is used. Assign transmit powers under the following assumptions:

- Gains are computed as  $G = k d^{-4}$  where  $k = 0.001$
- $d_{11} = 100$  m,  $d_{22} = 100$  m
- $d_{12} = 200$  m,  $d_{21} = 200$  m
- $P_{ro} = 10^{-12}$  W
- $SIR_o = 10$  dB

Repeat the exercise with  $d_{11} = 10$  m,  $d_{22} = 10$  m.

Repeat the exercise with  $d_{11} = 100$  m,  $d_{22} = 100$  m,  $d_{12} = 150$  m,  $d_{21} = 150$  m.

---